

2018-07

Demand-side management framework for deregulated electricity markets

Ngondya, Daniel John

NM-AIST

<http://dspace.nm-aist.ac.tz/handle/123456789/301>

Provided with love from The Nelson Mandela African Institution of Science and Technology

**DEMAND-SIDE MANAGEMENT FRAMEWORK FOR DEREGULATED
ELECTRICITY MARKETS**

Daniel John Ngondya

**A Dissertation Submitted in Partial Fulfillment of the Requirements for the Degree of
Doctor of Philosophy in Information and Communication Science and Engineering of
the Nelson Mandela African Institution of Science and Technology**

Arusha, Tanzania

July, 2018

ABSTRACT

Stability and reliability of electricity grids are at stake because of demand growth rate outstripping supply, aging of transmission and distribution infrastructure, and the energy sector globally is fast moving towards incorporating green sources of energy into national grids in order to stabilize and make the grid more reliable. These challenges have compelled researchers from various sectors to envisage a modern grid capable of autonomously managing demand, particularly where there is potential for reduction or shifting demand. Earlier efforts on demand side management of electricity focused on industrial and commercial consumers. However, residential demand side management programs are gaining popularity because of decreasing cost of smart meters, coupled with the fact that residences represent the fastest growing demand and have strongest potential for load reduction or shifting during peak hours. Works on residential demand side management have largely assumed a single utility supplying electricity to a number of consumers. Deregulation of the electricity sector such that multiple utilities offer services, has a potential to improve efficiency and provide value-added services to consumers. This study has developed a framework of interactions among utilities and between utilities and residential consumers aiming at improving grid reliability and stability. Using soft-systems methodology, models for interaction among utilities and between utilities and residential consumers were developed and evaluated using simulations. Interactions among utilities have been modelled as a Potluck Problem with non-rational learning so as to establish equilibrium demand and supply, taking into account past consumption patterns. Interactions between utility and consumers have been modeled and simulated using token-based scheduling so as to ensure equity and guaranteed access to shared power capacity established from interactions among utilities. Simulation of interactions and validation using actual consumption information indicates reduced variability between demand and supply with Mean Absolute Percentage Error of 5-33% and Peak Average Ratio of up to 27.7% . Consumers can discretionarily shift their demand at peak hours and save up to 16.6% of electricity cost. Coordinated use of green energy sources on the consumer side can reduce by up to 23.4% of potential reverse peaks, thereby decreasing loads dropped because of power capacity constraints. Developing countries characterized by insufficient generation, demand growth outstripping available supply and limited access to electricity have an opportunity to sustainably improve stability and reliability of their grids through the use of demand management programs and therefore may not need to solely rely on investment in new a generation.

Keywords: Demand Side Management, Smart Grid, Community Scheduling, Green-Aware Scheduling, Demand-Supply Variability, Deregulated Electricity Market, Potluck Problem.

DECLARATION

I, **Daniel John Ngondya**, do hereby declare to the Senate of Nelson Mandela African Institution of Science and Technology that this dissertation is my own original work and that it has neither been submitted nor is being concurrently submitted for degree award in any other institution.

Daniel John Ngondya, (Student)

Date

COPYRIGHT

This dissertation is copyright material protected under the Berne Convention, the Copyright Act of 1999 and other international and national enactments, in that behalf, on intellectual property. It must not be reproduced by any means, in full or in part, except for short extracts in fair dealing; for researcher private study, critical scholarly review or discourse with an acknowledgment, without the written permission of the office of DVC-ARI, on behalf of both the author and the NM-AIST

CERTIFICATION

The undersigned certify that they have read and found the dissertation titled, *Demand-Side Management Framework for Deregulated Electricity Markets* qualify for acceptance by the Nelson Mandela African Institution of Science and Technology (NM-AIST) in Arusha, in partial fulfillment of the requirements for the degree of Doctor of Philosophy in Information and Communication Science and Engineering of NM-AIST.



Dr. Joseph Wynn Mwangoka, (Supervisor)



Date

ACKNOWLEDGEMENTS

Three years of studies have been a journey that has taught me perseverance, patience, endurance and hard working. Luckily, everything went well because my research supervisors were always there to guide me. I am grateful to Dr. Joseph Mwangoka for his time, timely responses, and mentorship. It is because of that mentorship trees, bushes and forests of research work got cleared. In the same weight, my thanks are due to the late Dr. Yaw Nkansah-Gyekye for his guidance and accommodating me in his tight schedule during the final months of research. Dr. Yaw passed away on 17th *February*, 2018. May his soul rest in peace.

My heart-felt gratitude is also due to CoCSE Faculty members. Through your comments and criticism during presentations, I have been able to greatly improve my work and nurture my research skills. It is these skills that made the completion of this dissertation possible.

Moreover, I am grateful to the NM-AIST management for granting me scholarship to pursue my studies and for providing conducive environment for learning. All these made this work a success.

It would have been very difficult to grasp flexible and convenient document preparation mechanics without the assistance of Dr. Josiah Nombo right at the beginning of my studies, you are a friend indeed and in need.

Lastly, I would like to thank my family and relatives for encouragement and moral support during three years of study. Specifically, I would like to thank my uncle-Bernard Ngondya for his understanding of what I was going through during my studies. To my mother, I say thank you for your prayers. All members of my family gave me hope and strength during difficult times. To my wife-Neema and kids, I say thank you for enduring and coping with my absence at home during my studies.

DEDICATION

To the memory of my father, John Anyegile Ngondya.

TABLE OF CONTENTS

ABSTRACT	i
DECLARATION	ii
COPYRIGHT	iii
CERTIFICATION	iv
ACKNOWLEDGEMENTS	v
DEDICATION	vi
LIST OF TABLES	xi
LIST OF FIGURES	xiii
LIST OF APPENDICES	xiv
LIST OF ABBREVIATIONS	xv
CHAPTER ONE:	
Introduction	1
1.1 Background Information	1
1.2 Research Problem and Justification of Study	5
1.3 Research Objectives	5
1.3.1 General Objective	5
1.3.2 Specific Objectives	6
1.4 Research Questions	6
1.5 Significance of the Research	6
1.6 Dissertation Outline	7

CHAPTER TWO:

Demand Side Management in a Smart Grid	10
2.1 Introduction	10
2.2 Smart Grid Definition	10
2.3 Communication Infrastructure and Standardization	10
2.4 Smart Appliances	12
2.5 Smart Meters and Home Management Units	13
2.6 Deregulation of Electricity Markets	14
2.7 Demand Side Management Programs	16
2.7.1 Energy Efficiency Programs	17
2.7.2 Demand Response Programs	17
2.8 Conclusion	18

CHAPTER THREE:

A Systematic Literature Review of Residential Demand-Side Management

Programs	20
3.1 Introduction	20
3.2 Methods	22
3.3 Results	24
3.3.1 Authorship and Chronology	24
3.3.2 Geographic Diversity of DSM Programs	24
3.3.3 Disciplinary Diversity of DSM Programs	25
3.3.4 Characteristics of DSM Programs	27
3.4 Discussion	39
3.4.1 Surging Chronology of DSM Programs	39
3.4.2 Literature on DSM Programs is Geographically Limited	40
3.4.3 Literature on DSM Programs is Multi-Sectoral	41
3.4.4 Need to Balance Consumer Benefits against Utilities	42
3.4.5 Constraint on Power Drawn From Grid, Reverse Peaks and Renewable Energy Sources	43
3.5 Conclusion	44

CHAPTER FOUR:

Demand-Supply Variability in Deregulated Electricity Markets¹	45
4.1 Introduction	45
4.2 Management of Demand-Supply Variability in Electricity Grids	47
4.3 System Model	50
4.3.1 Problem Description	50
4.3.2 The Potluck Problem	52
4.3.3 Application to Deregulated Electricity Market	53
4.4 Proposed Algorithm	57
4.5 Simulation, Results and Discussion	61
4.6 Conclusion	67

CHAPTER FIVE:

Access Guaranteed Community-based Scheduling Algorithm²	69
5.1 Introduction	69
5.2 Demand Scheduling Approaches	72
5.3 Problem Definition	75
5.4 Proposed Consumption Scheduling	77
5.4.1 Consumption Scheduling without Guaranteeing Minimum Power	77
5.4.2 Consumption Scheduling with Guaranteed Minimum Power	80
5.5 Numerical Study	82
5.6 Conclusion	89

CHAPTER SIX:

Access Guaranteed and Green-aware Scheduling Algorithm³	91
6.1 Introduction	91
6.2 Related Work	92
6.3 Problem Definition	95
6.3.1 Solar Power Modeling	96
6.3.2 Storage Modeling	97
6.3.3 Green-Aware Demand Side Management Model	98

6.4 Green-Aware Consumption Scheduling 99
6.5 Numerical Study 100
6.6 Conclusion 107

CHAPTER SEVEN:

General Discussion, Conclusion, and Recommendations 108
7.1 General Discussion 108
7.2 Conclusion 110
7.3 Recommendations 110
7.4 Future Work 112

REFERENCES 114

APPENDICES 137

LIST OF TABLES

Table 1:	Authorship of Works on DSM Programs	25
Table 2:	Geographical Diversity of Studies on DSM Programs	26
Table 3:	Disciplines Studying DSM Programs	28
Table 4:	Various Techniques Used to Design DSM Programs	32
Table 5:	Motivations for Designing DSM programs	34
Table 6:	Benefits of DSM programs	34
Table 7:	Challenges of DSM programs	38
Table 8:	Description of Symbols Used	60
Table 9:	Simulation Parameters	82
Table 10:	Elastic Appliances	101
Table 11:	Fixed Appliances	101
Table 12:	Storage and PV	101

LIST OF FIGURES

Figure 1:	Illustration of demand shifting with DSM programs (Jamal, 2015) . . .	3
Figure 2:	Typical Structure of Deregulated Electricity Market (Abhyankar and Khaparde, 2013)	16
Figure 3:	Various Demand Response Programs (Davito <i>et al.</i> , 2010; Barbato and Capone, 2014)	18
Figure 4:	Number of research works on DSM programs over years.	27
Figure 5:	Consideration of area of study in DSM programs.	29
Figure 6:	Consideration of residents in studied DSM programs.	29
Figure 7:	Scheduling scope in studied DSM programs.	30
Figure 8:	Privacy considerations in studied DSM programs.	31
Figure 9:	Scheduling constraint on grid electricity capacity.	33
Figure 10:	Consideration for reverse peaks.	35
Figure 11:	Consideration of GES and storage in DSM programs.	36
Figure 12:	Performance evaluation of studied DSM programs.	36
Figure 13:	Experimental verification of studied DSM programs.	37
Figure 14:	Interaction between Utility company and Individual Residences. . . .	51
Figure 15:	Interactions among Utility Companies and Customer Segments. . . .	52
Figure 16:	Weight of predictors after convergence.	61
Figure 17:	Frequency of use of each predictor	62
Figure 18:	Convergence of a single utility at 0200 hours	63
Figure 19:	Convergence of four utilities at 2200 hours	63
Figure 20:	Convergence at different hours for a single utility	64
Figure 21:	Comparison between actual and optimal demand at 0700 hours	65
Figure 22:	Daily mean absolute percentage error for all four utilities at 0800 hours	65
Figure 23:	Demand-supply variability with consumers as potluck problem agents	66
Figure 24:	Interaction between Utility company and Individual Residences. . . .	72
Figure 25:	Interaction between Utility company and Communities.	73

Figure 26:	Interactions among multiple utilities and communities in a deregulated market.	73
Figure 27:	Maximum Power Capacity Constraint	83
Figure 28:	Access to shared maximum power capacity for all consumers with token-based algorithm	84
Figure 29:	Actual vs optimal Cost	85
Figure 30:	Frequency of connected loads at different Hours	86
Figure 31:	Daily deferred loads	86
Figure 32:	Frequency of deferred loads at various hours	87
Figure 33:	Access to token by various consumers	87
Figure 34:	Total consumed power by all consumers	88
Figure 35:	Access to shared power capacity by all consumers with random back-off based algorithm.	88
Figure 36:	Access to electricity at various hours with each consumer guaranteed minimum power and maximum power capacity shared using random back-off algorithm.	89
Figure 37:	Green-aware system schematic.	96
Figure 38:	Access to shared capacity.	102
Figure 39:	Green power consumed.	103
Figure 40:	Power consumed from the grid.	104
Figure 41:	Total consumed power(Grid+Green).	104
Figure 42:	Two reverse peaks for community with GES and storage.	105
Figure 43:	Three reverse peaks for community with GES and storage.	105
Figure 44:	Token-based scheduling algorithm without GES-all deferred loads shifted to 2300 hours.	106

LIST OF APPENDICES

Appendix 1: Details of 84 Papers Proposing Various DSM Programs	136
Appendix 2: Details of 84 Papers Proposing Various DSM Programs- <i>continued</i>	137
Appendix 3: Details of 84 Papers Proposing Various DSM Programs- <i>continued</i>	138
Appendix 4: Details of 84 Papers Proposing Various DSM Programs- <i>continued</i>	139
Appendix 5: Actual Demand vs Optimal Demand for Utility 1	140
Appendix 6: Actual Demand vs Optimal Demand for Utility 2	141
Appendix 7: Actual Demand vs Optimal Demand for Utility 3	142
Appendix 8: Actual Demand vs Optimal Demand for Utility 4	143

LIST OF ABBREVIATIONS

ANNs	Artificial Neural Networks
AMI	Advanced Metering Infrastructure
AMR	Automatic Meter Reading
AVP	Average Predictor
CPP	Critical Peak Pricing
DSM	Demand-Side Management
DSL	Digital Subscriber Line
FSP	Full Spot Pricing
Gbps	Gigabits per second
GES	Green Energy Sources
HAN	Home Area Network
HEM	Home Energy Management
HVAC	Heating, Ventilation and Air-Cooling
ISO	Independent System Operator
IEC	International Electrotechnical Commission
Kbps	Kilobits per second
kWh	Kilowatt Hour
LCD	Liquid Crystal Display
LED	Light Emitting Display
MAPE	Mean Absolute Percentage Error
Mbps	Megabits per second
MNP	Minimum Predictor
MXP	Maximum Predictor
NANs	Neighbourhood Area Networks
NGOs	Non-Government Organizations
NXA	MinMaxAverage

PAR	Peak Average Ration
PHEVs	Plug-in Hybrid Electric Vehicles
PLC	Power Line Communications
PSP	Partial Spot Pricing
PV	Photovoltaic
RNP	Random Predictor
RLP	Real-Time Pricing
RTP	Rational Predictor
SCADA	Supervisory Control and Data Acquisition
ToU	Time of Use
UK	United Kingdom
USA	United States of America
WANs	Wide Area Networks
WMA	Weighted Majority Algorithm

CHAPTER ONE

Introduction

This chapter describes the general introduction of the study. It mainly focuses on the background information of the study, the management of demand of electricity on the consumer side of the grid, in deregulated electricity market. It outlines the statement of the problem, research objectives, significance of the study and organization of the rest of the chapters.

1.1 Background Information

Recently, there has been growing interest in Demand Side Management (DSM) of Electricity. While earlier efforts focused on industrial and commercial consumers, the changing nature of residential load presents an opportunity to further manage electricity demand using envisaged modern electricity grid famously known as smart grid.

Energy consumption on the electric grid fluctuates from time to time depending on time of the day, day of the week, meteorological conditions, and type of consumers (residential, commercial or industrial). Fluctuating energy demands make it difficult for utility companies to plan electricity production in advance. Producing more electricity than can be consumed results in utility companies incurring unnecessary costs if excess electricity cannot be stored. On the other hand, producing less electricity than consumers' demands, will necessitate energy rationing thereby inconveniencing the consumers. Furthermore, generation capacities are planned so as to meet highest peak demand in a year. However, the full generation capacity is commonly in use only 5% of the time (Farhangi, 2010), which implies it is inefficiently utilized. Demand management allows utilities to handle fluctuations and improve stability and reliability of the grid. Previously, demand management was largely done on the supply side (reduction of technical losses); it is now increasingly accepted that doing it on the consumer side (DSM) will add more flexibility.

A DSM program allows a utility to plan, implement and monitor initiatives to modify its load shape on the consumer side. The idea of DSM of electricity can be traced back to 1970s following Arab Oil Embargo that triggered a raise in petroleum products (Warren, 2014a). Increase in both demand for electricity and price of petroleum products led to increase in price of electricity such that DSM was felt to be more cost-effective than to increase supply (Gyamfi and Krumdieck, 2011; Alahmad *et al.*, 2012). Traditional electricity grids are presently facing challenges such as aging infrastructure, growing demand, high air pollution and increasing accommodation of intermittent Green Energy Sources (GES) into the grid (Traber and Kemfert, 2011). These challenges are among the reasons researchers have been compelled to gain more interest in DSM programs in recent times, as explained in subsequent paragraphs.

Electricity grids have been around for decades and in some countries for centuries, as such, their generation, transmission and distribution infrastructures have aged to an extent that they are inefficient (due to energy losses), expensive to repair and maintain. More importantly, aging has reduced reliability of electricity (Li and Guo, 2006; Verbong *et al.*, 2013). Demand of electricity is growing at a rate that does not match with investment in new supply, especially in developing countries. By 2040, electricity demand will increase by 56% worldwide (Sieminski, 2014). It can be observed that sustainability and reliability cannot be achieved by merely increasing generation. Electricity grids account for 30% of global annual emissions (Haney *et al.*, 2010). International efforts to curb emission of greenhouse gases such as Paris Climate Change Agreement indicate raising awareness of the impact of global warming. The DSM programs are touted to reduce emission of greenhouse gases by ensuring efficient use of generated electricity (Oberghassel *et al.*, 2016; Union, 2014). Share of GES such as Solar and Wind Energy on the grid is increasing in response to initiatives meant to reduce emission of greenhouse gases and increasing demand. However, GES depends on weather conditions and therefore highly unreliable (Pina *et al.*, 2012). The DSM programs can be used to improve reliability and efficiency of electricity grids.

Challenges facing traditional grids have propelled researchers to envisage a more modern grid known as Smart Grid, also called Intelligent Grid. Unlike the traditional electric grid that is characterized by unidirectional flow of electricity from production plant to consumers, the

Smart Grid seeks to equip the grid with bi-directional flow of electricity and information from utility companies to consumers (Fang *et al.*, 2012). This presents an opportunity for utilities to automate demand management, especially on the consumer side, using DSM programs. A typical electricity demand curve consists of Peak-demand and Off-Peak demand as shown in Fig. 1.

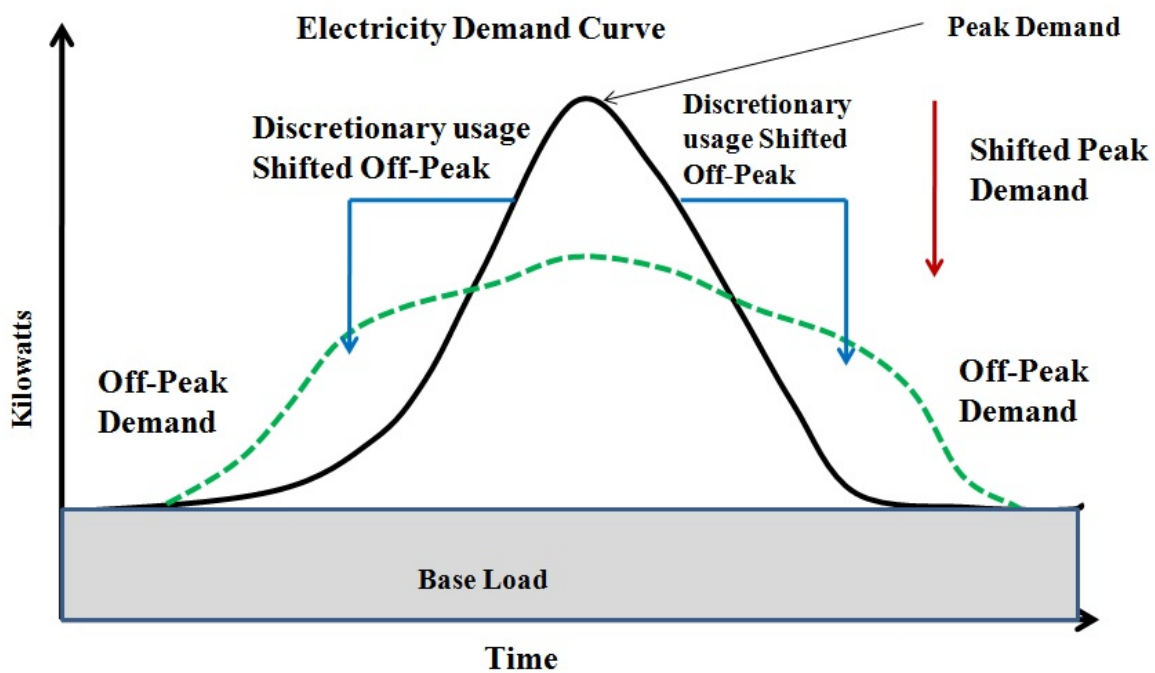

Figure 1: Illustration of demand shifting with DSM programs (Jamal, 2015)

The DSM programs intend to flatten a demand curve. Flattening is achieved by encouraging consumers to shift some of their tasks from peak to off-peak hours, in return for some incentives. Flattening of the demand curve does not necessarily result in reduced overall consumption. To achieve this, electricity prices need to be set based on actual generation costs instead of the commonly used flat rate pricing scheme. Since during peak hours expensive fossil fuels based plants are connected to the grid, the price tends to be higher than during off-peak hours where prices are lower because of the use of base plants (Hydro, Coal, Nuclear) which are typically cheaper than fossil fuel based plants. Flattening the demand curve is advantageous to both utilities and consumers. The former have a chance to reduce operational costs as they

can avoid the use of expensive peak-plants that use fossil fuels and the latter can save money supposed to be paid to utilities (Davito *et al.*, 2010; Barbato and Capone, 2014).

Automated DSM programs for industrial and commercial consumers have been in use for quite some time because it made economic sense to deploy smart meters (Siano, 2014). However, residential load is growing faster than industrial and commercial loads and has the largest potential for load reduction or shifting (Mazidi *et al.*, 2014; Molina-Garcia *et al.*, 2011). Automated Residential DSM programs are becoming even more popular because of decreasing cost of hardware, making wide-scale deployment of smart meters possible. Moreover, increasing and changing nature of residential consumption with the introduction of Plug-in Hybrid Vehicles (PHEVs) makes use of automated residential DSM programs viable (Galus and Andersson, 2008).

Essentially, DSM programs involve management of interactions associated with utilities and consumers. To manage demand-supply balance, management of interactions among utilities and between utilities and consumers is important. With regard to interaction between a utility and consumers, the work by Mohsenian-Rad *et al.* (2010) suggests a community based DSM program that enables consumers to save energy cost by shifting consumption at peak hours to off-peak. A utility benefits through flattened curve which means reduced consumption of peak plants and thereby less consumed fossil fuels. Additionally, the program further prevents self-interested consumers from taking advantage of the rest in the community. However, it is assumed there is only one utility in the market and it is budget balanced, that is, making no profit. Liu *et al.* (2014) proposes a DSM program enabling reduction of consumer electricity costs and Peak-to-Average Ratio (PAR), taking into account consumer thermal comfort and preferences. Consumers need to specify starting and ending times of their appliances one day in advance. Research by Cecati *et al.* (2011) taps into increasing use of green energy and storage in residences to enhance flexibility into DSM programs by integrating the sources with the grid, resulting in reduced consumer costs and flattened demand curve. The suggested DSM program requires complex communication system at consumer level.

As for interactions among utilities, there have been efforts to mitigate market power shown in work by Bjørndal *et al.* (2010) and Bose *et al.* (2014). Bjørndal *et al.* (2010) proposes a dynamic way of analyzing strategic behaviours of utilities towards electricity transmission. The

Independent System Operator (ISO) is tasked to ensure utilities are able to make profit without compromising optimal power flow to consumers. The work by Bose *et al.* (2014) presents a long-term way of identifying market power by considering residual power, minimum generation and network flow. These attempts to mitigate market power assumes no constraints on available capacity and therefore encourages a supply-follow-demand approach which is unsustainable.

Examined studies on DSM programs have assumed the presence of a single utility interacting with consumers to flatten demand. Deregulated electricity market introduces multiple utilities interacting with consumers, hence making both demand and supply of electricity prone to change. This work addresses variability of demand and supply by managing interaction among utilities and between utilities and consumers so as to improve grid reliability.

1.2 Research Problem and Justification of Study

Deregulation of electricity market leading into multiple utilities has the potential to revolutionize the market just as it happened to the telecommunication industry, resulting in better services and prices. However, it also leads to variability of both demand and supply because of multiple utilities operating in the electricity market, hence reducing grid reliability because of high PAR values.

This work, therefore, developed a framework for interactions of utilities and residential consumers in deregulated electricity markets so as to improve grid reliability.

1.3 Research Objectives

1.3.1 General Objective

The general objective was to examine interactions of utilities and residential consumers in deregulated electricity markets to improve grid reliability.

1.3.2 Specific Objectives

The specific objectives were:

- (i) To evaluate the extent of literature on residential DSM programs.
- (ii) To establish sustainable demand-supply equilibrium in deregulated electricity market.
- (iii) To develop an equitable and access guaranteed community scheduling algorithm.
- (iv) To evaluate the performance of equitable and access guaranteed scheduling algorithm with GES and storage.

1.4 Research Questions

This research was intended to answer the following questions:

- (i) What is the extent of literature on residential DSM programs?
- (ii) How can interactions among utilities lead to sustainable demand-supply equilibrium in deregulated electricity market?
- (iii) How can equity and guaranteed access be attained in community scheduling algorithm?
- (iv) What is the impact of GES and storage to the proposed community scheduling algorithm?

1.5 Significance of the Research

It is anticipated that the results of this work will be beneficial to consumers, utility companies, government, policy makers, smart appliance manufacturers and the academic world. Consumers have an opportunity to save money by shifting consumption to off-peak hours where generation costs are smaller and than those at peak hours. Utility companies can reduce operating costs as flatter demand curve lowers production costs of the normally expensive fossil-fuel based peak plants.

Allowing consumers to participate in demand management enables a government to defer investment in transmission and generation of electricity without compromising stability and reliability of the grid. It also assists in mitigating emission of greenhouse gases through reduced use of fossil fuel-based peak plants as governments are signatories to international treaties that emphasize on the use of clean energy.

Automation of DSM programs has the potential to make electricity market even more sophisticated than it already is. This necessitates improved regulation of the market. Results of this work can be used by policy makers to ensure interests of all parties are safeguarded.

Algorithms suggested in this work can be used by manufacturers of smart appliances and communication equipments to establish interactions among utilities and between one utility and consumers to ensure sustainable consumption of electricity. More importantly, this work improves current knowledge on DSM programs by demonstrating how sustainable consumption of electricity can be accommodated in demand scheduling programs.

1.6 Dissertation Outline

Organization of this dissertation is based on the NM-AIST's guideline on paper-based preparation of dissertations where each chapter after the introductory chapter is a paper or manuscript. This dissertation is organized into six chapters as explained in subsequent paragraphs.

Chapter Two presents a general background to smart grid and its associated components highlighting challenges and opportunities. Communication infrastructures and main standards associated with smart grid deployment are presented. Smart appliances are important aspect of DSM as they are supposed to respond to signals from consumers and utilities. Prospects of widespread adoption of smart appliances are discussed. A smart grid necessitates the overhaul of existing electric meters that are mainly electromechanical and electronic and replacing them with smart meters. The cost of smart meters has for sometime been a stumbling block to the implementation of smart grid. Studies assessing viability of large-scale smart meters deployment are discussed. Lack of efficiency has been the main challenge associated with traditional electricity grids. Deregulation of the electricity sector in various parts of the world

was motivated by the need to improve efficiency. The benefits and challenges of various deregulation approaches taken by different countries are presented. Although the idea of DSM has been around for decades, it has not been fully realized because traditional grids are characterized by unidirectional flow of information from utilities to consumers. Smart grid enables efficient implementation of DSM programs through bidirectional flow of information between utilities and consumers. Approaches to the design of DSM programs for use in the smart grid are discussed.

Chapter Three presents a systematic and quantitative review of academic literature on DSM programs. The extent of research on DSM programs' authorship and chronology, geographic diversity, disciplines interested in DSM and characteristics of the programs. Based on the review, directions for future works are pointed out and form the basis for the rest of the chapters. From this chapter, a manuscript titled "A Systematic Literature Review of Residential Demand-Side Management Programs" is presented.

Chapter Four addresses potential variability of both demand and supply in deregulated electricity market. The market is assumed to have multiple utilities serving different consumer segments. It is in the interest of a regulator to ensure grid reliability by establishing equilibrium demand and supply of the entire market. In the market, utilities purchase electricity from generators at wholesale prices and retail it to their consumers. In this chapter, the market is therefore modelled as a Potluck Problem with non-rational learning with utilities acting as both producers and consumers of electricity. Based on the potluck problem, an algorithm that makes use of past consumption data to establish current demand and supply (on hourly basis) is developed and analyzed. A paper titled "Demand-Supply Equilibrium in Deregulated Electricity Markets For Future Smart Grid" has been published based on this chapter.

Chapter Five presents an equitable and access guaranteed token-based scheduling algorithm. The algorithm assumes supply capacity constraints based on equilibrium demand and supply established in Chapter Three which enables utilities to determine supply capacity constraints for their various consumer communities. Since supply capacity is shared by all consumers in the community, equitable and guaranteed access to it is important for acceptance of DSM programs. The algorithm benefits consumers by enabling them to save money by shifting their consumption from peak to off-peak hours. Utilities benefit through improved

grid reliability as Peak-to-Average Ratio is reduced by consumption shifting. A paper titled “Token Based Scheduling For Access Guarantee in Deregulated Electricity Markets” has been published based on Chapter Five.

With consumption scheduling in Chapter Five, there is a possibility of shifting significant demand such that a new peak is formed in previously off-peak hours and therefore defeating the purpose of flattening the demand curve. Increasing accommodation of GES by consumers can be used to mitigate adverse impacts of consumption scheduling through coordinated discharging. In Chapter Six, a green-aware scheduling algorithm that coordinates discharging of stored energy while still maintaining access to shared maximum power capacity has been developed and analyzed. Results indicate the possibility of mitigating reverse peaks through coordinated discharge of consumers’ stored energy. A paper titled “Green-Aware Token Based Demand Scheduling For Electricity Markets” has been published.

Chapter Seven ties together what has been done, concludes the study and draws lessons from it. Lastly, recommendations on what has to be done by various stakeholders in the electricity sector are presented and directions for future works discussed.

CHAPTER TWO

Demand Side Management in a Smart Grid

2.1 Introduction

An idea about demand management at the consumer side was first floated in the 1970s (Warren, 2014a; Nemet, 2009) and various approaches were suggested. However, inadequate infrastructure for enforcing control mechanisms limited the coverage of programs to mostly industrial and commercial consumers. In the light of smart grid initiatives, DSM programs can be extended to residential consumers in convenient and cost-effective manner. This chapter discusses DSM issues from the smart grid perspective, explaining challenges and opportunities of various components pertaining to smart grid.

2.2 Smart Grid Definition

Smart grid refers to an envisaged modern grid that is meant to deliver electricity to consumers from suppliers using digital technology (Fang *et al.*, 2012). The use of digital technology is intended to reduce cost, mitigate emission of greenhouse gases, save energy and increase reliability and transparency. Smart grids are characterized by: self-healing, active participation of consumers in demand management, resilience against physical and cyber attacks, ensuring power quality for various needs, integration of all kinds of generation and storage types, enabling new products, services and markets and asset optimization and operational efficiency (Ghansah, 2009). Key components of smart grid include: Communication Infrastructure, Smart Appliances, Smart Meters, Sensors, Processors, Storage, Generators and Demand Management.

2.3 Communication Infrastructure and Standardization

Smart grid's infrastructure comprises of the traditional electricity grid and communications network. Information among utilities, consumers, regulators, generators and other stakeholders

is shared using the communications infrastructure. Types of information exchanged include price signals, control commands and capacity constraints. It is assumed that the smart grid communications will be organized into Home Area Networks (HANs), Neighbourhood Area Networks (NANs) and Wide Area Networks (WANs).

It is widely accepted that a palette of communication technologies will have to be used because of the diversified nature of smart grid stakeholders. The HANs connect all appliances in a residence to a smart meter using technologies such as ZigBee, WiFi, Power Line Communications (PLCs) and Ethernet. The HANs cover a distance of tens of meters. Since residences can have several appliances, it is important that technology employed to connect the appliances be cheap and scalable. The PLCs have huge potential as they need no new infrastructures and every appliance connects to a power line. However, PLC is not yet matured. ZigBee is also an ideal candidate with features such as low cost, simplicity and low power consumption. WiFi is more mature than PLC and ZigBee, while Ethernet may be a little more expensive as it requires installation of cable to each appliance (Fan *et al.*, 2013).

Through smart meters, NANs connect residences together in the neighborhood using ZigBee, WiFi, PLC or Cellular, depending on the distance from one residence to another. The NANs are supposed to cover several hundred metres in distance. Data rate requirements are in terms of tens of Kilobits per second (Kbs) and vary depending on the number of residences in the neighbourhood. A transformer unit that connects residences to the power line network may serve as an aggregation point of NANs communications (Fan *et al.*, 2013).

The WANs span tens of kilometres in distance and connects together several NANs to utilities. Desired data rates are in the order of hundreds of Megabits per second (Mbps) to several Gigabits per second (Gbps). Technologies suited to WANs communication include: Microwave, WiMAX, fiber optic links, Digital Subscriber Line (DSL) and 3G/LTE. Unlike HANs and NANs, technologies for WANs are already in place in many countries (Fan *et al.*, 2013).

In contrast to developed countries, their developing counterparts may face even bigger obstacles in implementation of smart grid. In developing countries, communication infrastructures are largely present in urban areas. Rural areas characterized by growing access to electricity cannot be left out of smart grid implementation (Aker and Mbiti, 2010).

Complexity of electric grids and communication networks necessitate use of different software, hardware and vendors; presenting an interoperability challenge. Some countries have taken effort to regularize and standardize smart grid. Guided by Energy Independence and Security Act of 2007, USA has regularized research and development of smart grid and by 2014 was able to come up with 72 standards related to smart grid. Globally, standardization of smart grid is led by International Electrotechnical Commission (IEC) which has identified over 100 standards relevant to smart grid (El-Hawary, 2014). The large number of standards formulated for smart grid reflects its complexity and possibly huge implementation costs. This calls for coordinated efforts in formulating the standards.

2.4 Smart Appliances

Smart appliances are physical appliances with capabilities for information processing and storage, wireless communication and network interface and physical interaction with their environment using sensors and actuators (Privat, 2006). Traditional appliances only have mechanical and electrical parts, smart ones additionally consist of sensors, microprocessors, data storage, controls, software (typically embedded Operating System) and enhanced user interface (Porter and Heppelmann, 2014).

Smart appliances are designed to respond to information from consumers, utility and environment in order to manage their loads. Increasing cost of electricity and awareness of environmental issues may prompt consumers to switch to smart appliances so as to make efficient use of electricity and save money. Moreover, work by Lund *et al.* (2014) indicate that the use of smart appliances will grow rapidly between 2017 and 2020. Although smart appliances have high initial cost, it has been observed that the cost can be offset within a year, while the appliances have an average lifetime of more than 10 years (Fuller and Parker, 2012). Smart appliances used have an important role to play in demand management as they can be managed autonomously.

2.5 Smart Meters and Home Management Units

An electric meter is a device that measures total electricity consumed by appliances drawing electrical energy from the main power supply. Electric meters can be classified into: (1) Electromechanical Meters, (2) Electronic Meters and (3) Smart meters. Electromechanical meters work by rotating a non-magnetic disc whenever power passes through it. Rotation speed depends on amount of power passing through it. Electronic meters have LCD/LED displays indicating amount of electricity consumed by connected appliance—they are much more efficient than electromechanical meters. In addition to measuring consumed electric energy digitally, smart meters are equipped with communication facilities for the purpose of communicating consumption, price and control information between utility and consumers (Effah and Owusu, 2014).

Smart meters have evolved from Automatic Meter Reading (AMR), AMR Plus and Advanced Metering Infrastructure (AMI). The AMR meters are characterized by automated monthly readings, one-way communication, tampering detection, and load profiling. The AMR plus meters have features such as one-way communication, daily or on-demand readings, hourly interval data and outage notification. The AMI meters boasts two-way communication capability, HAN interface, remote meter programming, integrated service switch, time-based pricing and power quality management (EEI-AEIC-UTC, 2011).

Smart meters have been in use for almost two decades now—mostly used by industrial and commercial consumers (EEI-AEIC-UTC, 2011). For developed countries, smart meters were deployed to industrial and commercial consumers so as to address their sophisticated prices and to provide more granular billing data requirements. For developing countries, they were mostly deployed to curb electricity theft. Industrial consumers account for most of utilities' revenues in developing countries. Factors such as decreasing cost of smart meters, potential for demand management and advancing billing requirements for all consumers, are making it viable to deploy smart meters to all consumers (Effah and Owusu, 2014; EEI-AEIC-UTC, 2011). It is reported by Deilami *et al.* (2011) that smart meter deployment in most parts of Europe, particularly Sweden and Italy, is approaching 100%. Work by Effah and Owusu (2014) shows that electromechanical and electronic meters have failed to prevent energy theft in and proposes

the use of AMI meters. Developing countries may seek to replicate benefits of smart meters on industrial and commercial consumers to residential ones, especially now that the price is decreasing. Moreover, in developing countries there is high use of electromechanical meters that requires utility personnel to physically visit residences and read the meters. Deployment of smart meters will reduce cost of manpower required to read meters as it will now be done remotely. However, success of smart meter deployment also depends on consumer's awareness of potential benefits, as there have been cases where consumers were reluctant to use smart meters, fearing loss of privacy.

Apart from smart meters, consumers may need to be equipped with energy monitoring tools. For residential consumers, Home Energy Management Units (HEM) are commonly used for monitoring, comparison and control of smart appliances. With HEM, consumers are able to monitor consumption of various appliances and hence take measures to manage save energy. The HEMs allow consumers to configure appliance settings such that a trade-off between cost and comfort is made. Nevertheless, there are concerns that HEMs stress consumers by showing consumption in real-time. Furthermore, potential intruders may hack HEMs and establish whether a residence is occupied or not by just observing consumption patterns (Rahman *et al.*, 2014).

2.6 Deregulation of Electricity Markets

Traditional electricity grids are characterized by centralized generation plants connected to a transmission system for transporting electricity to various parts of the country. Consumers are connected to the grid through distribution networks which connect to the transmission system. Until early 1990s, most electricity grids were vertical integrated-that is, basic components of the grid such as generation, transmission, distribution and retail supply; were owned and operated by a single utility company. With growing demand and aging infrastructure, performance of vertically integrates utility companies started to decline, particularly in developing countries. Operating costs increased rapidly, resulting in increase in price of electricity. At the same time, investment in new grid infrastructure was on the decline throughout the world. As a result, making electricity market competitive was felt important to address grid challenges.

Multiple utilities competing in retail supply were expected to provide value-added services, risk management, demand management and service quality differentiation taking into account load profiles (Bye and Hope, 2005).

Since the early 1990s, there have been significant efforts around the world to deregulate electricity markets so as to improve efficiency, reliability and power quality at low cost. Deregulation essentially seeks to separate potentially competing parts of the electricity grid such as generation, distribution and retailing. It is assumed that transmission of electricity is naturally monopolistic, therefore the government's role is to regulate the electricity market, manage and invest in transmission infrastructure. Deregulation has been done with considerable success in Nordic countries, UK, Colombia and Argentina; resulting in increase in investment in new capacity, reduction in grid losses, drop in electricity prices and improved reliability. There are also cases where deregulation has not met envisaged promises, like the state of California where some utilities exercised their market power; leading to extended blackouts and high electricity prices (Arango *et al.*, 2006).

Figure 2 illustrates a typical structure of deregulated electricity market. The structure may vary depending on deregulation model. The deregulated market includes the ISO, a government authority responsible for facilitating a balance between demand and supply on the grid. Generating companies sell electricity to consumers through retailers. To be able to transport electricity from generating plants to consumers, generation companies pay wheeling charges to ISO which owns transmission and distribution infrastructures (Abhyankar and Khaparde, 2013).

A number of models have been used to deregulate electricity markets with varying success. The models can be categorized into two: those emphasizing on privatization of public utilities so as to level the playing ground (e.g., Chile) and those that just open electricity markets to potential investors (e.g., UK) (Arango *et al.*, 2006). Generally, experience from successful deregulated electricity markets indicate that continuously enabling competition is crucial. This includes keeping in check utilities' market power so as to protect consumers and encourage investment in new generation. However, addressing market power may necessitate privatization of publicly owned monopoly utilities.

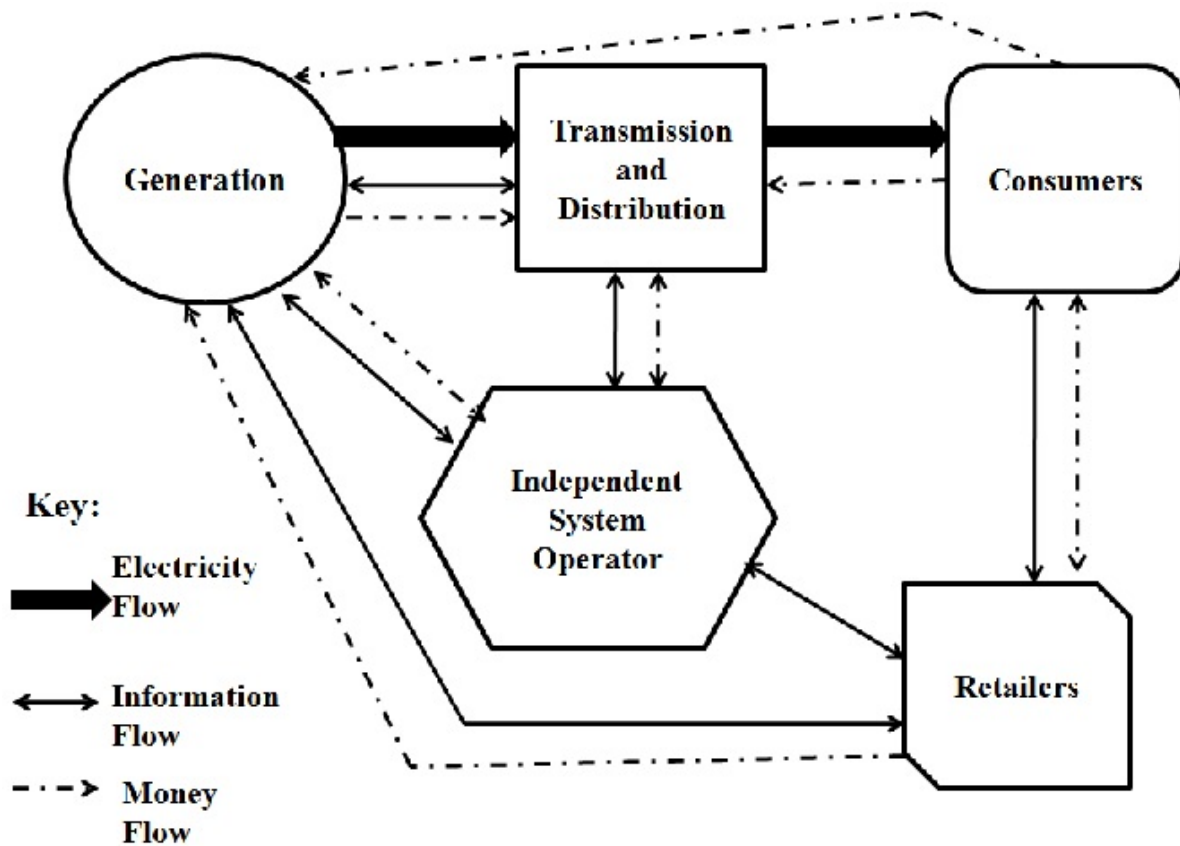

Figure 2: Typical Structure of Deregulated Electricity Market (Abhyankar and Khaparde, 2013)

Because of investments made over years on monopolistic utilities, discussions about privatization sparks patriotic and nationalist emotions, resulting in stalling or lack of support for deregulation initiatives (Ahlborg and Hammar, 2014). For example, in Tanzania, in the last two decades, four different teams of experts have been selected to advise on how well deregulation can be attained. All teams recommended unbundling of the electricity sector, however, no implementation was done (Ministry of Energy and Minerals, 2014). Success of Tanzania’s recently established, gradual, deregulation plan (2014-2025) may largely depend on political will.

2.7 Demand Side Management Programs

Traditionally, utilities have been managing demand from their side by reducing transmission losses and increasing generation capacities. However, there is recently a trend of seeking to

manage demand on the customer side (Eissa, 2011). Programs that are used by utilities to control energy consumption at the customer side are collectively called DSM Programs. The DSM programs can mainly be categorized into two: Energy Efficiency programs and Demand Response programs.

2.7.1 Energy Efficiency Programs

Energy Efficiency programs focus on encouraging users to use less energy while still enjoying the same level of service. For example customers can be asked to change old light bulbs with more energy efficient Tube Lights. For buildings requiring heating, occupants can be asked to turn up a thermostat a few degrees during hot days to reduce air conditioning.

2.7.2 Demand Response Programs

Demand Response programs, also called load shifting programs work by transferring customer demand from peak hours to off-peak (valley) hours. By shifting daily peak demand flattens the general demand curve, allowing utilities to provide more electricity using less expensive base generation. There are two main types of demand response programs, namely: Incentive-based and Price-based programs (Eissa, 2011).

Incentive-based programs allows consumers to receive monetary payments after reducing their loads at times requested by utilities. Utilities would request consumers to reduce their loads when electric generation prices are high or their grid is unreliable. It can be implemented in terms of Cash compensation or Bill rebates (Davito *et al.*, 2010).

With price-based programs, consumers are charged different prices per day to reflect value and cost of electricity at that particular time. Time of Use (ToU) pricing, Real-time pricing (RLP) and Critical Peak Pricing (CPP) are the commonest pricing methods for price-based programs. The ToU sets low and high prices for off-peak hours and peak hours respectively. The prices are set in such a way that consumers are compelled to use less electricity during peak hours and more electricity during off-peak hours. The RLP divides a day into time slots-e.g., one hour slots and charges different prices for the slots. The CPP charges extremely high rates during critical peaks. There is also Inverted Block Pricing (IBP) that increase rate for higher

user customers (Barbato and Capone, 2014; Davito *et al.*, 2010). Figure 3 illustrates demand response programs.

The DSM programs can be implemented manually or automatically. Although DSM programs have been in use for decades, they have not been popular among consumers because they have mainly been implemented manually. Manual implementation makes them too demanding to consumers. It becomes difficult for consumers to adjust their consumption according to prices and even calculating how much they are saving on their electricity. Declining costs of smart meters, smart appliances and communication infrastructure presents an opportunity to improve performance and convenience of DSM programs through automation. In the literature, the terms "DSM programs" and "demand response programs" have been used interchangeably. In this work, whenever used, the term "DSM program" refers to a specific automated demand response program.

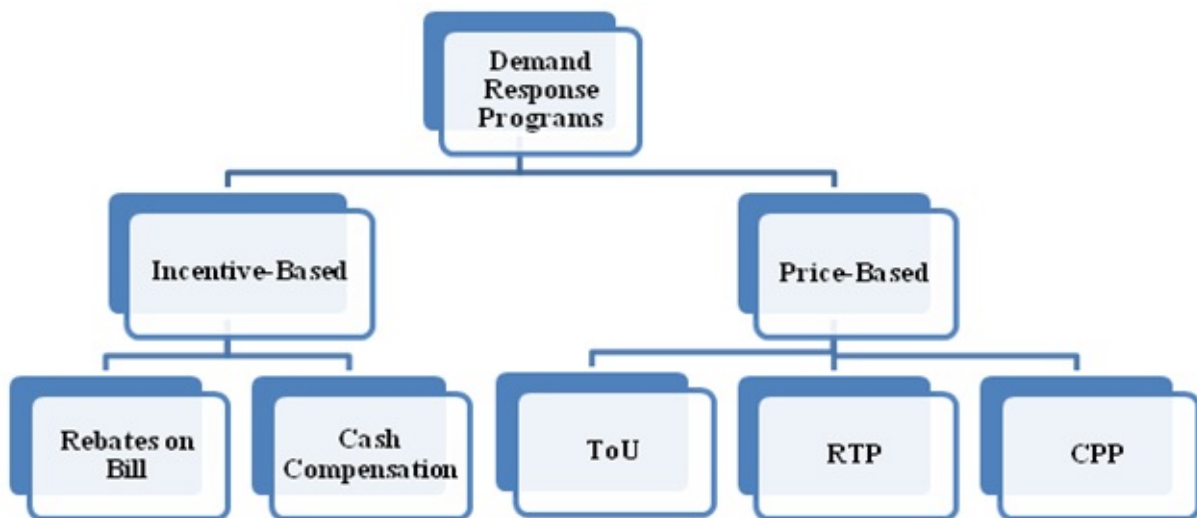

Figure 3: Various Demand Response Programs (Davito *et al.*, 2010; Barbato and Capone, 2014)

2.8 Conclusion

In this chapter, various issues affecting smart grid and subsequently DSM implementation have been discussed. It has been noted that although DSM programs have been around for decades, lack of automation discouraged their large-scale adoption, particularly by residential

consumers. Factors such as decreasing cost of smart meters, potential for cost savings for utilities and consumers and smart grid initiatives are likely to make DSM programs attractive and convenient to consumers. The next chapter (Chapter Three) examines the extent of academic literature on residential DSM programs.

CHAPTER THREE

A Systematic Literature Review of Residential Demand-Side Management Programs

Abstract: Electricity demand is growing at a rate that does not match both with available supply and rate of investment in new generation. Accommodation of intermittent green energy sources into the grid in order to reduce emission of greenhouse gases makes attainment of a balance between supply and demand even more difficult. Demand Side Management Programs may be employed to maintain the balance. Most researchers have focused on qualitative assessment of the literature on demand management programs. This review sought to evaluate the extent of academic literature on demand management programs-specifically examining (i) authorship and chronology of residential DSM programs, (ii) geographic diversity, (iii) disciplines interested residential DSM programs, and (iv) characteristics of residential DSM programs. Eight four original papers on residential demand management programs were selected in 2 rounds. The first round involved selecting the papers from 6 scholarly databases using keywords. In the second round, selected papers were validated using their references. Predefined categories were used to group the selected papers. Analysis of the categories indicate that recently there have been growing interest in DSM programs, although it is mainly in Europe and North America. Developing countries can achieve more stability, reliability and sustainability of their grids by investing in DSM programs instead of solely focusing on capacity generation to catch up with growing demand.

Keywords: Demand Side Management, Market, Demand Scheduling, Renewable Energy Sources, Residential Demand Management, Smart grid.

3.1 Introduction

Balancing of demand and supply is important for electricity grid reliability. Factors such as increasing demand, accommodation of renewable energy sources and changing nature of electric loads are threatening grid reliability.

It is estimated that consumption of electricity will increase by 56% by 2040 (Sieminski, 2014). This increase is quite significant considering that some developing countries are not even generating enough to serve current demand. Up to 30% of annual greenhouse gas emissions worldwide is attributed to electric grids; as such there is mounting pressure to accommodate renewable energy sources to the grid (Haney *et al.*, 2010). However, renewable energy sources are highly intermittent-fluctuating depending on weather and climatic conditions (Dallinger and Wietschel, 2012; Pina *et al.*, 2012). Introduction of PHEVs presents an additional and different kind of load to the electric grid (Galus and Andersson, 2008). It is evident that grid stability and reliability cannot be achieved sustainably by solely increasing generation capacities. The DSM Programs should be used in addition to investing in new generation capacities.

Demand side management refers to programs that seek to reduce or shift energy consumption through efficiency improvements or shifting load on the customer side of the electric grid (Logenthiran *et al.*, 2012). The DSM program encourages customers to consume less during peak demand and more during off-peak demand through financial incentives and behavioural change. The DSM programs enable utilities to defer investments in electricity generation and therefore meet future energy demand in a diverse and cost effective manner. It reduces air pollution and water user for generation. For customers, DSM presents an opportunity to reduce their bills though financial incentives offered by utilities (Khan *et al.*, 2014; Davito *et al.*, 2010).

Challenges facing electric grids threaten their stability and reliability. The DSM programs may be used to address the challenges thereby improving grid stability and reliability. In this paper, a comprehensive and systematic review is carried out to establish the extent of English literature on residential DSM programs. We specifically seek to answer five research questions: (i) Who has done research on residential DSM programs? (ii) What is the geographical spread of residential DSM programs? (iii) What type of issues are being studied? (iv) What types of methods are employed in residential DSM programs? (v) What patterns can be found in the results?

Unlike many similar works that review DSM programs based on a narrative approach, this work provides a quantitative perspective of efforts towards DSM. Main contribution of this work is

to identify research gaps forming a basis for works from Chapter Four to Chapter Six.

3.2 Methods

In research, reviews can be categorized into three common types, namely: narrative, systematic, and meta analysis. Narrative reviews attempt to critique and summarize a body of selected literature about a topic. A basis for selection of the literature is not necessarily made open to the readers. Since narrative reviews have no objective and clear methods section, they are suited to authors who are experts in the field as they largely depend experience and subjectivity (Cipriani and Geddes, 2003). A systematic review seeks to critically compare all empirical evidence fitting a pre-selected eligibility criteria in order to answer a specific research question (Liberati *et al.*, 2009). Meta analysis reviews use statistical techniques to summarize and combine results of studies done independently (Grant and Booth, 2009). With meta analysis, it is assumed that by combining information from several related studies, more precise estimates can be made about a topic than from individual studies. It is common for systematic reviews to also include meta analysis, although this is not always the case (Liberati *et al.*, 2009). Cipriani and Geddes (2003) argues that meta analysis should be conducted in the context of systematic reviews in order to avoid systematic bias resulting from poor quality studies. Moreover, synthesis of literature in systematic reviews includes content analysis as observed by Sørensen *et al.* (2012).

Systematic quantitative literature review is preferred to narrative literature review because it allows a researcher to come up with reviews that are reliable and reproducible (Guitart *et al.*, 2012; Roy *et al.*, 2012). Systematic quantitative reviews seek to reduce bias by clearly articulating well in advance how papers are found, selected and categorized. Of main interest to systematic quantitative reviews is evaluation of geographical coverage of literature on particular topics, type of both methods and results obtained. The main sources of papers being reviewed are scholarly databases. Systematic quantitative reviews are increasingly becoming a common way of reviewing scholarly works in an objective manner as it can be observed in works by Guitart *et al.* (2012), Roy *et al.* (2012) and Steven *et al.* (2011), especially in DSM reviews by Warren (2013, 2014b).

In this chapter, 115 articles written in English were selected from the following six scholarly databases: Google Scholar, Science Direct, Sage, African Journals Online (AJOL), SpringerLink and Semantic Scholar. With the exception of Semantic Scholar which is a Computer Science based journal, the rest are multi-disciplinary. The keyword 'Demand Side Management' was used to select papers in combination with words: 'residence', 'deregulated market', 'electric grid', 'smart grid', 'renewable energy', 'electricity storage', 'community' and 'scheduling'. Synonyms such as 'home', 'domestic' and 'house' were used instead of residence; and 'neighborhood' instead of community. Only original research papers published in the visited journals were selected. Reference lists of 3 top ranked papers were used to triangulate selected papers, and additional 32 articles were selected-making a total of 147. Sixteen works regarding theses, reviews, patents, books and conference proceedings were excluded, leaving 131 articles. Thirty one articles merely investigating factors affecting performance of DSM programs such as occupancy variances, load profiles and consumption behavior were also excluded, leaving 100 of them.

Initially, 10 papers (10% of selected articles-100) were stored in an Excel Database organized around 17 predefined categories. Later, 3 categories were dropped (market type, architecture and pricing scheme) since they did not adequately characterize DSM programs. New categories such as consideration for privacy, constraints on power consumed from grid, consideration of GES and storage, experimental verification and consideration of reverse peaks were added so as to capture clearly DSM program concepts. Finally, remaining articles were classified as according to 17 categories as follows: paper title, author(s), author affiliation, journal, discipline, publisher, year, study location, residence considerations, consumer participation, motivations, methods used, effect of study, experimental verification, challenges, benefits, privacy consideration, reverse peaks, power capacity constraints and integration of GES. Targeting dynamic and autonomous DSM programs instead of manual ones, qualitative synthesis of articles stored in the database further excluded 16 of them. As a result, only 84 papers were considered for synthesis of contents.

3.3 Results

Eighty four papers on electricity's dynamic DSM programs published between 1991 and 2016 were identified and analyzed. Details of the papers are as indicated in Table 1 in the Appendix section. The papers indicate chronological, geographical, disciplinary and methodological diversity of research on DSM programs as presented from sub-section 3.3.1 to sub-section 3.3.4.

3.3.1 Authorship and Chronology

Research on DSM programs has attracted interest of various researchers around the world as indicated in Table 1. Most authors are from the USA (20.1%), followed by Spain (19.1%) and Canada (13.6%). Most studied DSM programs are by authors from USA (24.7%), Spain (14.1%) and Canada (11.8%).

Although the idea of demand management of electricity has been around since the late 1970s (Gyamfi and Krumdieck, 2011); studies about dynamic DSM programs have mainly been conducted starting from 1990s as it can be observed from Fig. 4. Over 95% of works examining DSM programs have been published between 2008 and 2016 (See Fig. 4).

3.3.2 Geographic Diversity of DSM Programs

Twenty seven countries in 4 continents have shown interest in DSM programs as shown by Table 2. Most of these countries are in Europe (48.1%) and Asia (33.3%). Although a few countries (7.4%) in North America have shown interest in DSM programs; they constitute 37.6% of studied DSM programs-only second to Europe (40.0%). Oceania and Africa shows least interest with 4.7% and 2.4% of studied DSM programs, respectively.

Table 1: Authorship of Works on DSM Programs

Country	DSM Programs	Authors
USA	21	58
Spain	12	55
Canada	11	34
Italy	7	19
Iran	4	13
Australia	4	13
Germany	3	10
China	3	12
UK	2	12
Finland	2	11
Turkey	2	5
Portugal	1	5
France	1	5
Singapore	1	5
Pakistan	1	4
Belgium	1	3
India	1	3
Ireland	1	3
Romania	1	3
Saudi Arabia	1	3
South Africa	1	3
Switzerland	1	2
Croatia	1	2
Denmark	1	1
Tunisia	1	2
Netherlands	0	1
Norway	0	1
Total	84	288

3.3.3 Disciplinary Diversity of DSM Programs

Researchers from a number of disciplines have shown interest in managing electricity demand (see Table 3). Papers have been classified into Energy and Buildings, Smart Grid, Information and Communication Technology (ICT), Sustainable Energy, Power and Energy Systems, and Others. Number of papers per discipline is Energy and Buildings (30), Smart Grid (26), ICT (11), Sustainable Energy (8), Power and Energy Systems (7), and others (2).

Table 2: Geographical Diversity of Studies on DSM Programs

Continent/Country	Total
Africa	
South Africa	1
Tunisia	1
Total	2
Asia	
China	3
India	1
Saudi Arabia	1
Iran	4
Pakistan	1
Singapore	1
Turkey	2
Total	13
Europe	
Spain	11
Italy	7
Germany	3
Finland	2
UK	2
Portugal	1
France	1
Belgium	1
Ireland	1
Romania	1
Switzerland	1
Croatia	1
Denmark	1
Total	34
North America	
Canada	11
USA	21
Total	32
Oceania	
Australia	4
Total	4

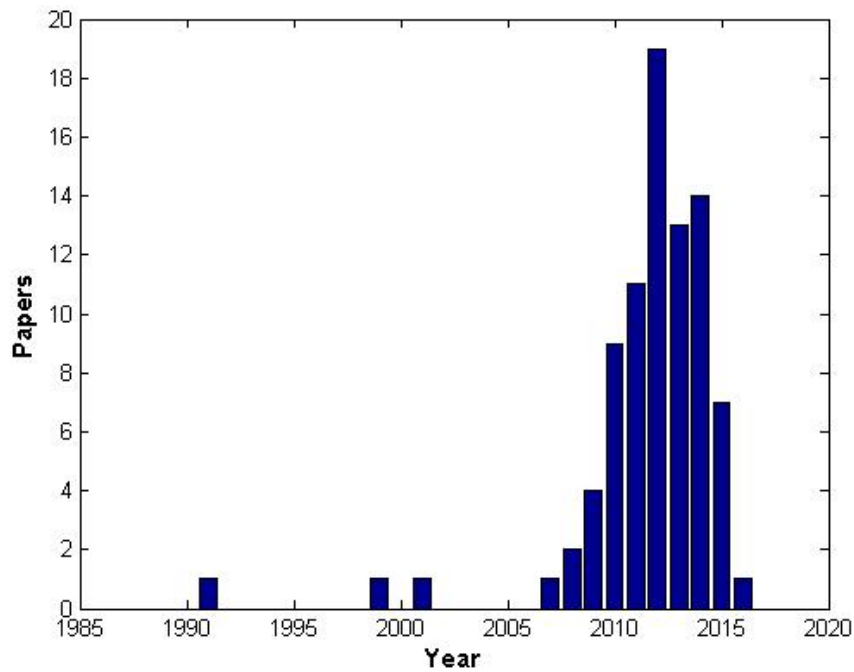

Figure 4: Number of research works on DSM programs over years.

3.3.4 Characteristics of DSM Programs

Studied DSM programs were characterized by factors such as study location, consideration of residents, scheduling scope, privacy considerations, constraint on power drawn from grid, reverse peaks consideration, integration with GES and storage, performance of the DSM programs and experimental verification of the programs as explained in detail in subsequent paragraphs.

Success of a particular DSM program is dependent on the location where it is implemented as it is influenced by weather and climatic conditions. Out of 84 papers examined, specific locations were considered in 51.0% of them; while 49.0% assumed general study locations as it can be observed in Fig. 5.

The nature of residents and their economic activities affect consumption and subsequently, performance of DSM programs (Martinaitis *et al.*, 2015). Examined papers indicate that only 20% of them took into account occupants of residences where DSM programs were studied. In the rest of papers, residents were not considered in evaluation of the proposed DSM programs as shown in Fig. 6.

Table 3: Disciplines Studying DSM Programs

Discipline	Journal	Papers	Total
Energy and Buildings(7)	Applied Energy	12	30
	Energy	1	
	Energy and Buildings	7	
	IEEE Transactions on Energy Conversion	1	
	Energy Conversion and Management	3	
	Energy Efficiency	2	
	Energy Policy	2	
	Indoor and Built Environment	2	
Smart grid(1)	IEEE Transactions on Smart Grid	26	26
ICT(7)	IEEE Journal of Selected Topics in Signal Processing	1	10
	Intelligent Industrial Systems	1	
	Cognitive Computation	1	
	Neural Computing and Applications	1	
	IEEE Transactions on Industrial Informatics	4	
	Sensors	1	
	Consumer Electronics	1	
Sustainable Energy(5)	IEEE Transactions on Sustainable Energy	1	9
	Solar Energy	2	
	Renewable Energy	2	
	IET Renewable Power Generation	1	
	Sustainable Energy	3	
Power and Energy Systems(3)	Electric Power Systems Research	3	7
	International Journal of Electrical Power & Energy Systems	1	
	IEEE Transactions on Power Systems	3	
Other(2)	Applied Thermal Engineering	1	2
	Service Science	1	

Demand management of electricity involves scheduling appliances such that consumption at peak hours is reduced while increasing it at off-peak hours. Scheduling of appliances can be done per single residence or a group of residences as indicated in Fig. 7, where out of 84 works, residential, community, both residential and community scheduling were employed in 63, 19 and 2 works, respectively.

One of the concerns for dynamic DSM programs implementation is privacy of consumers. A program that divulges consumption information to the public does not inspire confidence to the consumers (Karlin, 2012). Figure 8 shows that 11.0% of the papers examined took privacy of consumers into account, while the rest did not.

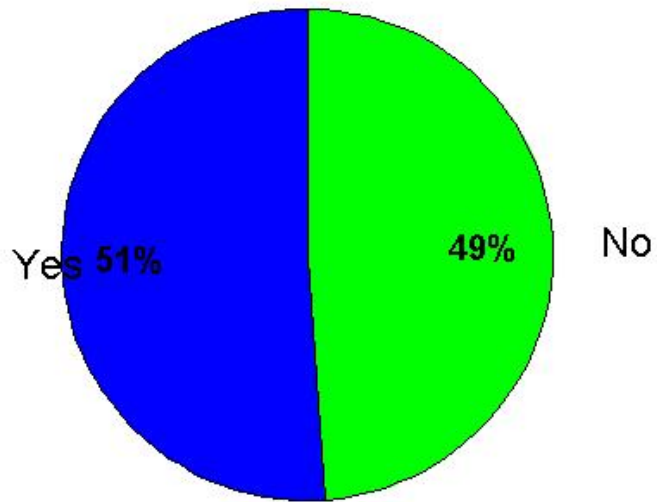

Figure 5: Consideration of area of study in DSM programs.

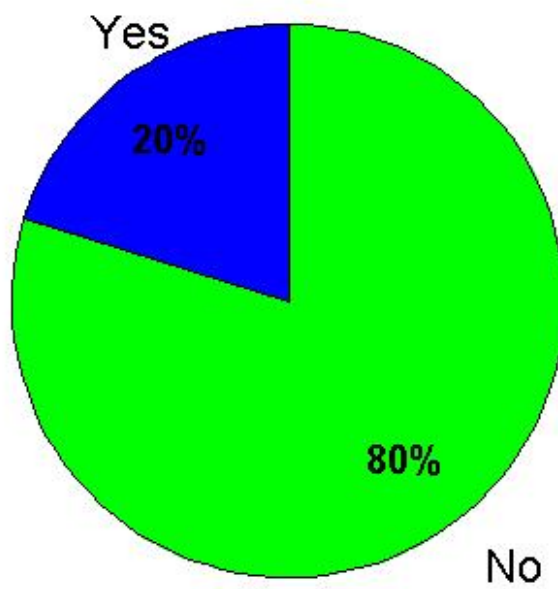

Figure 6: Consideration of residents in studied DSM programs.

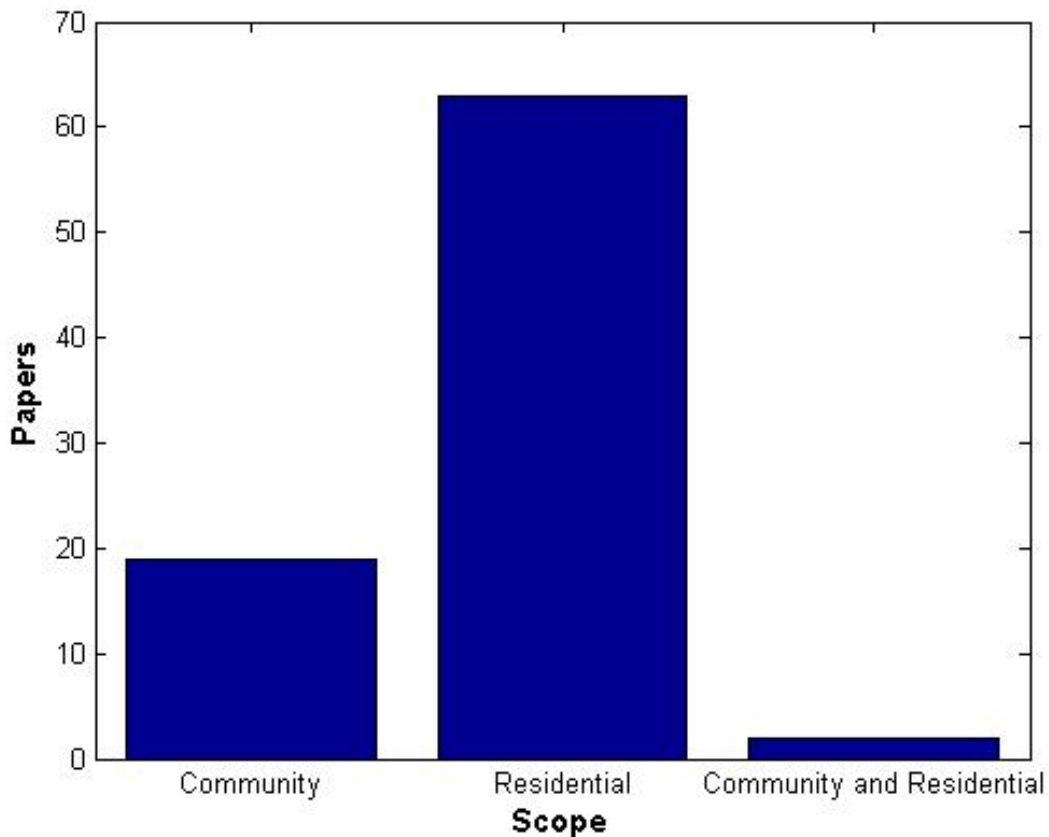

Figure 7: Scheduling scope in studied DSM programs.

The DSM programs in studied papers were analyzed to see if they assumed an upper bound on electricity consumed from the grid in their proposed scheduling. Out of 84 papers studied, 23 (27%) constrained power drawn from the grid; while 61 (73%) assumed unlimited supply of electricity from the grid as illustrated by Fig. 9.

A reverse peak (also known as "rebound peak", "new peak") refers to negative effects of consumption scheduling that causes formation of new peak during hours it did not occur previously (Ferruzzi *et al.*, 2015; Fischer *et al.*, 2016). Consumption scheduling works under assumption that consumers will shift their demand from peak to off-peak hours-in return for some incentives. So there is a possibility of an 'Avalanche Effect' such that too many consumers shift their tasks to off-peak hours and thereby creating an even high peak, hence defeating the purpose of consumption scheduling. Analysis of studied works indicate only 12 (14.0%) works considered reverse peaks in their proposed DSM programs. Seventy two works (86.0%) did not consider, as illustrated by Fig. 10.

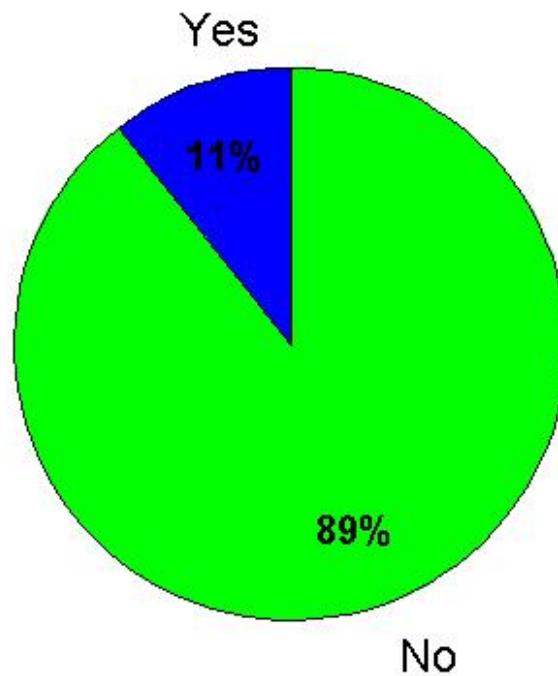

Figure 8: Privacy considerations in studied DSM programs.

Integration of GES (wind,solar) and storage owned by consumers into proposed DSM programs was analyzed. Out of 84 papers, 45 (54.0%) papers considered; while 39 (46.0%) didn't, as shown in Fig. 11. With regard to motivations in the studied papers (see Table 5); performances of various proposed DSM programs were observed and can be categorized as either positive or negative depending on whether the motivations demonstrated positive or negative results, respectively. 96.0% of examined papers indicated positive results, while 4.0% showed negative results (see Fig. 12).

Figure 13 shows whether experimental evaluation has been done on suggested DSM program or not. Out of 84 examined papers, 21.0% of them have DSM programs evaluated experimentally while 79.0% were only simulated. Various techniques have been used to design DSM programs as noted in Table 4. Management of electricity demand has most frequently been formulated heuristically (11.7%) and as Linear Programming(7.4%), Mixed Integer Linear Programming (7.4%) and Decision Support System (7.4%).

Table 4: Various Techniques Used to Design DSM Programs

Design Technique	DSM Programs
Heuristic	11
Mixed Integer Linear Programming (MILP)	7
Linear Programming	7
Decision Support System	7
Genetic Algorithm	6
Artificial Neural Networks(ANNs)	5
Dynamic Programming	5
Stochastic Model	4
Tool	4
Game Theory	3
Monte Carlo	3
Particle Swarm Optimization	3
Fuzzy	2
Machine Learning	2
Model Predictive Control	2
Sub-gradient	2
Adaptive Neural-Fuzzy Learning	1
Agent-Based Models	1
Bi-Level Programming	1
Binary Integer Programming	1
Branch and Bound	1
Branch and Cut	1
Central Moving Average	1
Chance Constrained Programming	1
Convex Programming	1
Economic Dispatch	1
Enumerated Programming	1
Least Enthalpy Estimation	1
Multi Attribute Decision Making	1
Newton-Based Load Flow	1
Newton-Raphson	1
Non-Linear Least Squares	1
Non-Linear Programming	1
Programmable Logic	1
Receding Horizon	1
Stochastic Dynamic Programming	1
Time-Domain	1

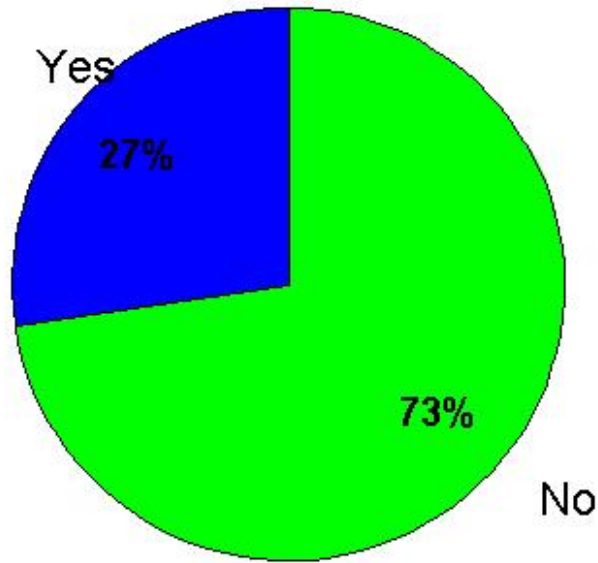

Figure 9: Scheduling constraint on grid electricity capacity.

Although motivations and benefits are similar, they are discussed separately in this section. Motivations of DSM programs discuss desires for managing electricity demand while benefits demonstrate them. Motivations for employing DSM programs in residences are shown Table 5. The most common motivations for using DSM programs were to reduce consumer costs (24.3%), reduce peak demand (18.3%) and Consumer Comfort Maximization (16.5%). The least common motivations (0.46%) were increasing consumer rebates, reducing both load shedding and raw material import.

Benefits of using DSM programs for consumers and utilities are as summarized in Table 6. Most examined papers have demonstrated that consumer cost reduction (31.9%) is the main benefit of DSM programs, followed by peak demand reduction (19.0%) and consideration for consumer preference and comfort (16.5%).

Table 5: Motivations for Designing DSM programs

Motivation	Total
Reduce consumer costs	53
Reduce peak demand	40
Consideration for consumer preference and comfort	36
Improve electrical load behaviour (stability, reliability)	22
Maximize GES consumption	16
Improve efficiency	10
Minimize energy drawn from the grid	9
Reduce emission of greenhouse gases	9
Defer investment in new infrastructure	4
Cost savings for utilities	4
Maximize social welfare	4
Maximize power sold to grid	3
Reduce reverse peaks	1
Reduce market power	1
Allow regulator to prioritize optimizations	1
Reduce Load shedding	1
Guarantee energy supply	1
Reduce raw material import	1
Reduce combustion of fossil fuels	1
Offer rebates to consumers	1

Table 6: Benefits of DSM programs

Benefits	Total
Consumers can save money	47
Flatter demand curve/reduced PAR	28
Consideration for consumer preference and comfort	24
Improve electrical load behavior (stability, reliability)	11
Increased self-consumption	9
Reduced grid energy consumption	9
Improved efficiency	6
Reduced emissions of greenhouse gases	4
Cost savings for utilities	3
Increased power sold to the grid	2
Flexibility for ISO to choose optimization parameters that addresses stakeholder needs	1
Minimize market power	1
Rebates to consumers	1
Defer investment in new generation	1

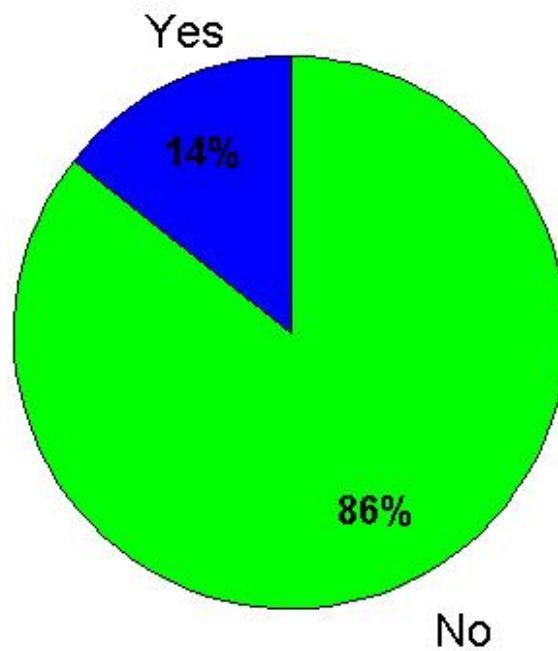

Figure 10: Consideration for reverse peaks.

Challenges that consumers and utilities face with regard to use of DSM programs are summarized in Table 7. The most common challenges include high cost of GES and Storage facilities (11.3%), Scheduling discomfort (11.3%) as consumers are required to wait for some time before running their appliances or run them outside comfort zone. Furthermore, for efficient operation of DSM programs; demand forecasting is required. However, forecasting errors affect performance of DSM programs (10.4%).

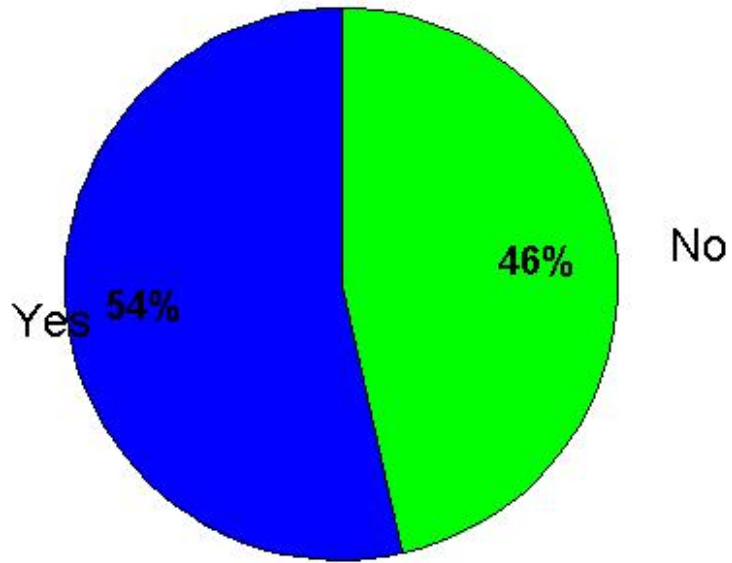

Figure 11: Consideration of GES and storage in DSM programs.

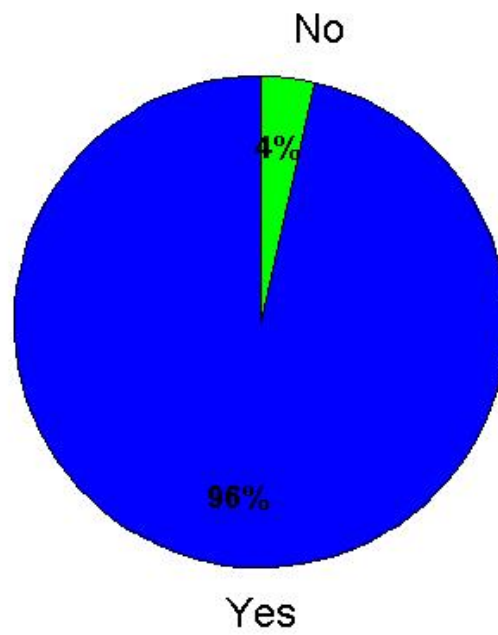

Figure 12: Performance evaluation of studied DSM programs.

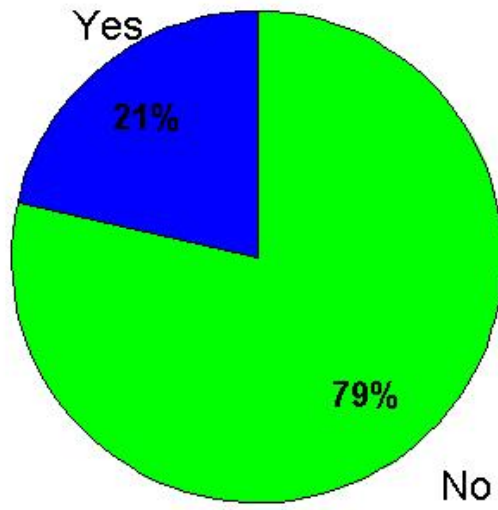

Figure 13: Experimental verification of studied DSM programs.

Table 7: Challenges of DSM programs

Challenges	Total
High cost of GES and storage	13
Scheduling discomfort	13
DSM program affected by forecasting errors	12
Requires consumers to adhere to schedules/certain obligations	8
Suboptimal schedules may be generated	8
Direct control of appliances by utilities	8
Reverse peaks	6
Cost savings being smaller than investment required	6
Utilities profits may be reduced/utility not making profit	6
Communication constraints not taken into accounts	4
DSM program success dependent on pricing	4
Consumers may be required to schedule their appliances 1 day before	4
DSM results vary depending on weather,pricing and housing	3
Penalizing consumers for not abiding to schedule	3
DSM programs may not account for unusual conditions	2
Cost savings May be insignificant depending on weather conditions	2
Limited life-cycle and calendar life of storage	2
Slow convergence	2
Lack of understanding of factors influencing consumption patterns	1
Interferes with consumers' routine/consumer inconvenience	1
Consumer behavior is rarely taken into account	1
Consumer privacy may be compromised	1
Consumers need to establish in advance how long appliances will run	1
Financial benefits of both consumers and utilities not considered	1
Need for incentives to consumers and/or utilities	1
Cost savings decrease with increase in appliances	1
CO ₂ reduction not significant in some cases	1

3.4 Discussion

A quantitative systematic review of DSM programs in electricity markets that examines peer-reviewed and original research papers written in English has been conducted. The review intended to establish authorship and chronology, geographical and disciplinary diversity, techniques and the resulting outcomes of researched DSM programs, as expounded in subsequent subsections.

3.4.1 Surging Chronology of DSM Programs

Systematic review has demonstrated that starting from the late 2000s to to-date, there has been a surge in research about DSM programs in electricity markets. Since the idea of demand management of electricity has been around for several decades, the recent surge could be attributed to (1) Decreasing cost of hardware and subsequently smart meters; (2) Increasing deployment of smart meters, especially in Europe and North America; (3) International agreements to mitigate emission of greenhouse gases; and (4) Enactment of laws establishing and regulating a modern grid (Smart grid).

Implementation of DSM programs requires the use of smart meters that allow interactions between utilities and consumers in order to communicate price changes and capacity constraints. Since most electric grid still use traditional meters, DSM programs call for the overhaul of the existing meters and replace them with smart meters. For deployment of smart meters to make sense, benefits associated with DSM programs must exceed the cost of deployment. Popularity of DSM programs in recent times suggests decreased cost of manufacturing smart meters are observed in studies by Gallo *et al.* (2013) and Rusitschka *et al.* (2009).

Since the late 2000s, various European and North American countries have embarked on wide-scale deployment of smart meters in residences. The move may be attributed to enactment of laws encouraging research and development of smart grid around the same time-for example USA's Energy Independence and Security Act of 2007 (USA, 2007). Thirty percent of global greenhouse gas emissions come from electric grids (Haney *et al.*, 2010). The need to adhere to international agreements to reduce emission of greenhouse gases such as the Paris Agreement

may have propelled countries to consider the use of DSM programs in order to reduce the use of fossil fuels. It is, therefore, possible that the first two reasons explain better the recent surge in DSM programs research.

Although the trend indicates that developing countries have been left out in deployment of smart meters in residences, AMR has been to curb energy theft of large power users (Tanesco, 2017). Success of AMR meters in developing countries, coupled with decreasing cost of smart meters may encourage utilities to consider deployment of smart meters in residences.

3.4.2 Literature on DSM Programs is Geographically Limited

Research on DSM programs in electricity markets has predominantly been conducted in Europe and North America as this review has demonstrated. Possible explanations for this skewness include: (1) Historical dominance of European and North American countries in natural science research; (2) Enactment of laws establishing and regulating the smart grid in most European and North American countries; (3) Ratification of international treaties aiming to reduce emission of greenhouse gases (4) Need for sustainable use of energy sources.

According to Hamel (2007), most of natural science research papers written in English journals are from Europe and North America. However, this trend is likely to change with time and therefore a multi-lingual review would explain better geographical diversity of DSM programs.

Most of the countries that dominate research in DSM programs have passed laws guiding development, deployment and regulation of Smart grid, with DSM programs as the centerpiece of the initiative. For example, the USA passed the Energy Independence and Security Act in 2007 (USA, 2007) that aims at increasing energy efficiency of buildings, products and vehicles. The European Union has come up with Strategy 2020 where members states seek to reduce emissions of greenhouse gases 20%, increase share of renewable energy by 20% and increasing energy-efficiency by 20% (Union, 2014). More importantly, they recognize DSM programs as being poised to achieve those targets.

Despite cost reduction being the main motivation of DSM programs, oil-rich countries such as Saudi Arabia and Iran have shown interest. It is possible that these countries have embraced the

idea to reduce emission of greenhouse gases and understand that fossil fuels are not infinite, hence seeking to consume them in sustainable manner.

One of the common benefits of DSM programs is improved grid stability and reliability which means more efficient utilization of existing grid assets to address long term sustainability. DSM programs are increasingly being implemented in the developed world while developing countries are lagging behind; despite their demand growth exceeding supply. Instead of solely focusing on increasing generation to match with growing demand, developing countries would do better by also investing in DSM programs in order to attain sustainability in the long run. Increased deployment of smart meters will enable more accurate verification of DSM programs as opposed to current practice where they are largely verified through simulations. It will also enable research to take into account factors that affect accuracy of results-for example, residents' behaviour, weather and nature of residences; leading to DSM programs that truly reflect real scenarios.

3.4.3 Literature on DSM Programs is Multi-Sectoral

Various disciplines have shown interest in DSM programs and possibly, this explains the number of diverse techniques that have been used to design DSM programs. For instance, the work by Magnier and Haghghat (2010) has approached demand management problem from construction industry perspective, taking into consideration housing standards to determine the impact of proposed DSM program.

In works by Gutiérrez *et al.* (2009) and Erol-Kantarci and Mouftah (2011), the authors have modeled appliances and smart meters as a sensor network, allowing demand management decisions to be carried autonomously. Consumers may be skeptical about their privacy, especially when most of the proposed DSM programs do not take it into considerations as demonstrated in this review. The fact that other parts of the communication system provide privacy may not be good enough to inspire confidence in consumers.

Transportation industry issues associated with expected use of PHEVs have been discussed by Deilami *et al.* (2011) and Gatsis and Giannakis (2012). Their impact on residential load and suggestions on how grid stability and reliability will be attained have been presented.

Among the examined papers, the commonest challenge in implementation of DSM programs is high cost of GES and Storage. Distributed generation introduces flexibility in DSM programs and therefore improving consumer comfort without compromising grid stability and reliability. Tax exemptions may be necessary in order to encourage those in the construction industry to consider on-site generation of electricity.

Basically, energy, communications, finance, construction, environment, manufacturing and transportation sectors are affected by DSM programs. Policy formulations regarding use of DSM programs may be more successful if it involves stakeholders from different sectors.

3.4.4 Need to Balance Consumer Benefits against Utilities

Most common motivation and benefit of DSM program is financial savings for consumers. This can be attributed to both increasing cost and demand of electricity (Sieminski, 2014). In the literature, various strategies have been considered to reduce cost of electricity, for instance: use of RES, DSM and deregulation of electricity markets so as to encourage competition. While RES promises low running costs, startup costs are relatively high (Di Giorgio and Pimpinella, 2012). Moreover, different countries have different potential for RES. Although deregulation is meant to encourage competition and thereby reduce costs, if not correctly designed and regularized, it is likely to result in even higher prices because of collusion and market power (Liu *et al.*, 2014). As for DSM, electricity prices need to set in such a way they do not cause loss for utilities or create reverse peaks. Potential reduction in profit margins for utilities may discourage them to embrace DSM initiatives, necessitating governments to grant subsidies to utilities to cover reduced profits.

Rather than solely focusing on consumer financial savings, It is important to evaluate both consumer and utility financial savings resulting from the use of DSM programs as it has been done by Roscoe and Ault (2010) and Surlles and Henze (2012). That is, reduction in PAR caused by DSM need to be translated into financial savings for utilities. Studies should investigate frameworks that establish combination of percentage reduction in PAR for given number of consumers, type and cost of generation and cost savings for both consumers and utilities.

3.4.5 Constraint on Power Drawn From Grid, Reverse Peaks and Renewable Energy Sources

Considerably, DSM programs evaluated schedules consumption assuming unlimited power capacity from the grid. This may be attributed to the fact that most authors of those works are from the developed world, where grids are characterized by balanced demand and supply, regardless of weather or increasing demand. On the contrary, grids in developing countries face challenges such as insufficient generation capacity, low access levels and demand growth rate that does not match with investment in new generation. Therefore, although most authors have assumed no constraint on power drawn from the grid- for the sake of sustainability and reliability, there has to be an upper bound for it, regardless of available generation capacity.

To a large extent, fossil fuels drive electricity grids; but they are being depleted at higher rate than nature can replenish them (Bozkurt *et al.*, 2010). Moreover, consumption of fossil fuels is attributed to global warming and climate change. While grids are also increasingly accommodating renewable energy sources, they are intermittent and depends on meteorological conditions. However, constraints should not be applied at the expense of consumer comfort, but rather exploit consumers' willingness to defer consumption in exchange for financial incentives or cost reduction on their electricity bills. Likewise, rather than applying arbitrary power capacity constraints as observed in works by De Angelis *et al.* (2013) and Wu *et al.* (2015), past consumption patterns should be taken into account so as to avoid compromising consumers' comfort. While constraints can be applied per residence or group of residences, it should be done on the latter so as to encourage maximum utilization of scheduled capacity constraint, coordinate efforts to mitigate reverse peaks and exploit heterogeneity of consumers so as to increase demand shifting potential. Mechanisms to guarantee access to shared capacity or ensure scheduling fairness for each residence in the group need to be addressed.

Self-generation using renewable energy sources such as Solar and Wind is increasing, particularly in countries with insufficient generation capacity (Bozkurt *et al.*, 2010). The DSM programs can be designed to tap into this potential so as to reduce both adverse impacts of capacity constraints (e.g., dropped loads) and scheduling discomfort while providing an opportunity for consumers to make money by selling electricity surplus to the grid. Moreover,

coordinated use of self-generation may be used to reduce reverse peaks and dropped loads in the case of constrained power capacity from the grid.

3.5 Conclusion

It is unsustainable to rely only on electricity generation to maintain demand-supply balance. The DSM programs provide an opportunity for consumers to actively participate in demand management. While most reviews focus on qualitative assessment of DSM programs, this review has systematically evaluated the extent of academic literature in DSM programs. Interest in DSM programs by various sectors is soaring, particularly in Europe and North America. Countries in the developing world have a chance to improve grid stability, reliability and access by embracing and investing in DSM programs. Future works may seek to strike a balance between consumer and utility benefits, particularly financial benefits. Comparison and experimental verification of different DSM programs design techniques will add more value. Works investigating comfort versus sustainability or reliability resulting from application of power capacity constraints on DSM programs should be studied. The next chapter (Chapter Four), presents a mechanism for addressing demand-supply variability in the deregulated electricity market, based on which power capacity constraints can be established and therefore be imposed on scheduling algorithms so as to foster sustainable and reliable consumption of power.

CHAPTER FOUR

Demand-Supply Variability in Deregulated Electricity Markets¹

Abstract: Deregulation of electricity market has a potential to improve efficiency, reduce costs for both customers and utilities and improve customer services if implemented correctly. However, it also introduces variability of both demand and supply. For grid stability and reliability, supply and demand must be matched at all times. In this work, the deregulated electricity market has been modelled in a game-theoretic manner as a Potluck problem with non-rational learning, in order to achieve demand-supply equilibrium on an hourly basis. In this work, an algorithm that uses past demand-supply patterns to establish current ones, in a non-rational learning manner has been proposed. Hourly supply and demand data for Danish electricity market from March to June 2016 were used to test the algorithm. Four utilities were simulated as producers and consumers of electricity, each using past 10 days data, in each iteration to determine current supply and demand. It has been observed that an equilibrium position can be established after 12 iterations and hence reduce supply-demand variability. Scheduling algorithms can be used together with the proposed algorithm to manage demand at peak hours by encouraging customers to consume more during off-peak hours and less during peak hour and thereby reducing cost for both customers and utilities.

Keywords: Deregulated Electricity Market, Smart grid, Electricity Grid, Grid Stability, Demand-Supply Variability, Potluck Problem, Non-rational Learning, Weighted Majority Algorithm, Multiple Utility Companies, Independent System Operator.

4.1 Introduction

Electric grids are known to have huge inertia and long transmission and distribution distances and therefore do not readily respond to change in demand (Ulbig *et al.*, 2014). However,

¹ This chapter is based on a published paper titled:

Ngondya, D., Mwangoka, J.(2017). Demand-Supply Equilibrium in Deregulated Electricity Markets for Future Smart Grids. *Cogent Engineering*, 4(1),1392410. <https://doi.org/10.1080/23311916.2017.1392410>,

increasing accommodation of renewable energy sources into the grid decreases overall grid inertia and hence the need to establish demand-supply equilibrium at all times.

Traditional electric grids consist of components such as generation plants, transmission, distribution and retail supply that are commonly owned and managed by a single state-owned utility company. Complexity of each of the components coupled with increasing demand for electricity, inefficiency, increase in number and types of distributed small plants, preference of renewable energy sources and need to reduce electricity costs have propelled countries to think of alternative way of organizing the grid (Lewis and Nocera, 2006).

Deregulation of electricity market so that there are several institutions running various components of the grid has the potential to improve efficiency, reliability and stability of the grid. Moreover, customers can have their electricity costs reduced and additionally can get value-added services because of competition among utilities. Typically, deregulation of electricity market means having several players in generation and retail supply while keeping transmission and distribution components legal monopolies. This provides an opportunity for customers to choose their preferred cost or service quality package from multiple competing utilities. Utilities purchase power from plant owners at wholesale price and sell to consumers at a retail price (Joskow, 2008).

While deregulation of electricity market has been a success in Chile, Texas, Argentina and Nordic countries, if partially or incorrectly implemented it can lead to significant potential costs as it happened in California (Joskow, 2008). Since deregulation presents a scenario where there can be both multiple utilities and customers, both supply and demand of electricity will vary from time to time. In this case, it is important to manage strategic interactions of utilities.

Strategic interactions can be managed by using Structural Analysis which is an *ex ante* approach (Bose *et al.*, 2014). Other approaches include Competition Models and Behavioral Analysis, which are basically *ex post*. According to Oulton (2007), both theoretically and practically, *ex post* approaches can perform better than *ex ante* ones depending on the choice of parameters. Previous approaches to balance supply and demand have not taken into account cost, possible collusion among market participants and passive nature of customers. In this

work, behaviour of a deregulated electricity market with both multiple utilities and consumers modelled as a Potluck Problem with non-rational learning is analyzed.

In this chapter, an algorithm to establish equilibrium between supply and demand of electricity is studied so as to achieve grid stability and reliability. Similar works attempt to predict demand, therefore making supply follow it-which is not sustainable because of limited resources. Main contributions of this work are:

- (i) Modelling of deregulated electricity market as a Potluck Problem with Utilities acting as both consumers and producers.
- (ii) Development of an Algorithm that reduces variability of demand and supply of electricity using Potluck Problem with Non-Rational Learning.
- (iii) Establish a basis for utilities to determine capacity constraints for their consumers to adhere to. Power capacity constraints are important for sustainable and reliable consumption of electricity.

4.2 Management of Demand-Supply Variability in Electricity Grids

Challenges of managing the grid by single utility companies are exacerbated by increasing demand, accommodation of intermittent renewable energy sources to the grid and changing nature of loads (e.g., electric vehicles) (Lewis and Nocera, 2006). This has led researchers to imagine a deregulated electricity market with multiple utilities where demand as well as supply varies.

Whether it is a vertically or Horizontally integrated market (single and multiple utilities markets, respectively); balancing supply and demand on the grid is important for its reliability and stability. Unlike other commodities that can be efficiently stored in bulk; electricity demand and supply must be matched in real-time (Griffin and Puller, 2009; Joung, 2008; Müsgens *et al.*, 2014). If supplied electricity is higher than demand at any time, there will be loss of electricity. Otherwise, customers will face blackouts.

In traditional vertically integrated electricity markets, a single utility that controls generation, transmission, distribution and retail supply is able to balance supply and demand by maintaining an operating reserve (Ela *et al.*, 2011). Supervisory Control and Data Acquisition (SCADA) Systems are used to monitor and control the grid through automation. They provide operational flexibility, easy data collection, maintenance and report generation for decision making (Cardenas *et al.*, 2009). However, as pointed out by USA (2015), controllability with SCADA is reactive. Modern electric grids could do with more predictive and proactive control systems.

In deregulated (horizontally integrated) markets, there are several utilities, each of them interested in maximizing profits, therefore little incentive to worry about balancing the grid (Doorman, 2003). An ISO is responsible for ensuring the interests of the public are observed. The ISO manages the operation of the grid, schedules generation, maintain physical parameters of the grid, guides investments in transmission infrastructure and ensures that supply meets demand at all times (Joskow, 2008). Several approaches have been proposed to address demand-supply variability in deregulated electricity sector. The approaches include Storage, DSM, Auctions and Market Power Mitigation.

Two methods have been identified for storage of electricity, namely: Battery and Flywheel. Viability for storing excess generated electricity is investigated using the two methods by Walawalkar (2008). It was observed that using Sodium Sulfur-based batteries for storage did not make economic sense, while using flywheels was considered viable economically. Additional costs were required to equip the grid with flywheel-based storage system in order to balance supply and demand which may be an obstacle. As noted by Joung (2008) and Vinois (2012), it is too expensive to store electricity in bulk.

Demand side management refers to efforts by ISO or utilities to reduce costs by encouraging customers to efficiently manage their loads. It works by encouraging customers to shift some of their consumptions from peak hours (where the cost of electricity is higher) to off-peak hours and if they adhere, they get economic incentives (Khan *et al.*, 2015). According to Momoh (2012), various approaches have been employed to design DSM programs. Some of the approaches include: Decision System (Mohsenian-Rad and Leon-Garcia, 2010; Fadlullah *et al.*, 2014; Dai and Gao, 2014),

Intelligent Systems (Palensky and Dietrich, 2011; Matallanas *et al.*, 2012), Dynamic programming (Kishore and Snyder, 2010) and Evolutionary Programming (Khan *et al.*, 2015).

In a study done by Kumar and Sekhar (2012), a DSM program for deregulated electricity market has been considered with ISO responsible for enforcing the program. The ISO tries to reduce transmission line congestion by using DSM and thereby balancing supply and demand of electricity at any time. However, the proposed solution requires active participation of customers so that they respond to change in supply or price. Moreover, there is a limit to demand elasticity. So supply-demand variability can not rely on DSM programs alone.

Using auctions to encourage competition among wholesalers and retailers is another approach used to balance supply and demand. Auctions can be held at both wholesale markets where generators sell to utilities and at retail market where utilities sell to customers. Auctions that allow customers to participate are assumed to be both more efficient and competitive and hence addressing the issue of market power associated with generating companies (Kirschen, 2003; Kleit, 2007; Rassenti *et al.*, 2002). Kleit (2007) proposes a Full Spot Pricing (FSP) scheme in order to handle supply-demand variability. Based on prices and demands at a particular time, customers place their bids on the spot market. A Partial Spot Market (PSP) can be considered as FSP is prone to large price variations and need customers to actively adjust usage based on prices. In PSP, utilities sign long term contracts with generators regarding daily quantity of electricity to be supplied and in case there is more demand, auctions at the spot market are used to cover the deficit (Doorman, 2003). PSP means utilities cannot benefit from sustained decrease in prices because they are tied to ones in long term contracts (Joskow, 2008).

Market Power is defined as the ability of some of the market participants to raise (or reduce) prices profitably above competitive levels and maintain them for a significant time. Market power can be categorized as Vertical, Horizontal or Cartel-like. It is vertical market power when one participant controls two or more parts of electricity value chain-e.g., generation and transmission. Horizontal market power is when a market participant has broad geographical access (or broad scope of service) to one element of the value chain. It is cartel-like market power if a group of companies have market power over consumers (Faruqui and Eakin, 2012; Ilic *et al.*, 2013). Since participants exercising market

power may result in imbalance of supply and demand, researchers in (Bose *et al.*, 2014) have developed a long-term method of identifying market power based on minimum generation, residual supply and network flow. Market Power mitigation is essentially a policy issue-if deregulation is carried out and guided correctly, then there should be none.

Existing approaches to addressing supply-demand variability in deregulated electricity market do not keep track of consumption behaviour, they are too demanding to customers as they require their active participation and are not cost-effective. The proposed algorithm addresses supply-demand variability by allowing utilities to independently establish hourly demand and therefore decide what to supply at each hour. Demand-Supply equilibrium is established by taking into account past consumption patterns. The algorithm does not require active participation of the users. It assumes there is a communication infrastructure (already in place for most utilities) and past consumption information is accessible to utilities.

4.3 System Model

4.3.1 Problem Description

Traditionally, electric sectors all over the world have been vertically integrated geographic monopolies; owned by state or private companies. A single utility company is responsible for generation, transmission, distribution and retail supply (Joskow, 2008).

Deregulation of electricity market seeks to vertically separate potentially competitive segments e.g., generation, marketing and retail supply. Transmission and distribution systems can be run as regulated monopolies. Utilities buy varying amounts of electricity from generators at wholesale market and retails it to customers. Deregulation intends to benefit customers by allowing them to choose their preferred price and service quality combination from among several utility companies operating at the market (Joskow, 2008). Figure 14 and Fig. 15 illustrate interactions between customers and utility companies in vertically and horizontally integrated electricity markets, respectively.

Suppose there are N utility companies operating in N customer segments; total supply of electricity at particular hour is the sum of all electricity supplied by all N utilities at that

particular hour (see Equation 1). Likewise, total demand is equal to the sum of individual demand in N customer segments, as shown by Equation 2.

$$S_h = \sum_{i=1}^N S_{i,h} \quad (1)$$

$$D_h = \sum_{i=1}^N D_{i,h} \quad (2)$$

$$S_h \neq D_h \quad (3)$$

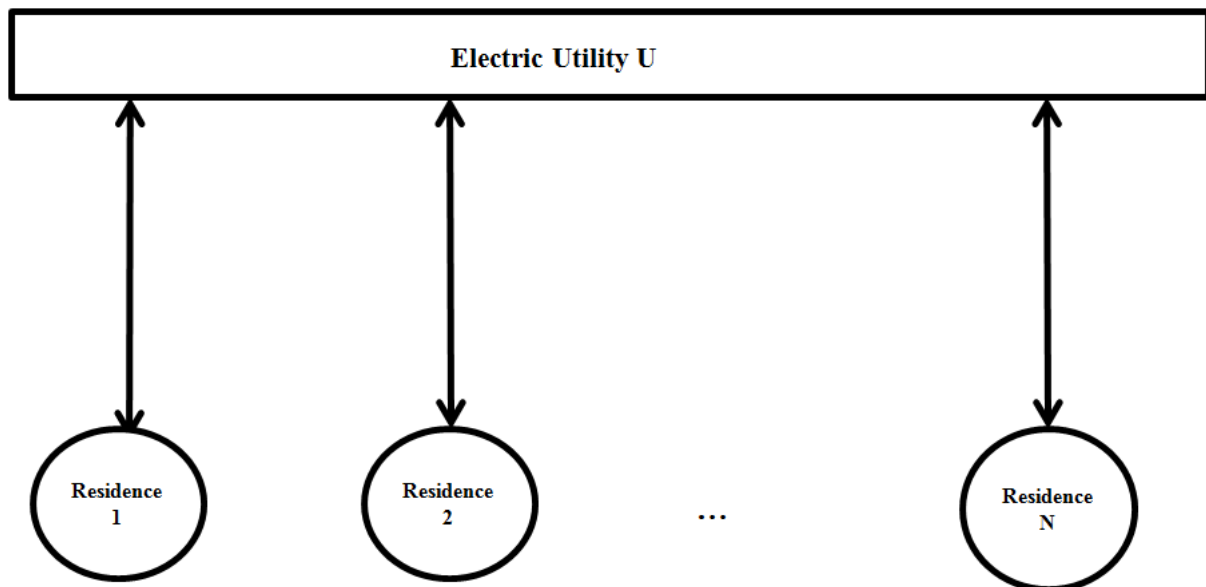

Figure 14: Interaction between Utility company and Individual Residences.

Having multiple utilities serving different customers in a given market presents a situation where total supply of electricity varies as well as the total demand, as in Equation 3. Moreover, utilities may have no incentive to share their supply information because of competition among them. Hence the market can be modelled as Potluck Problem.

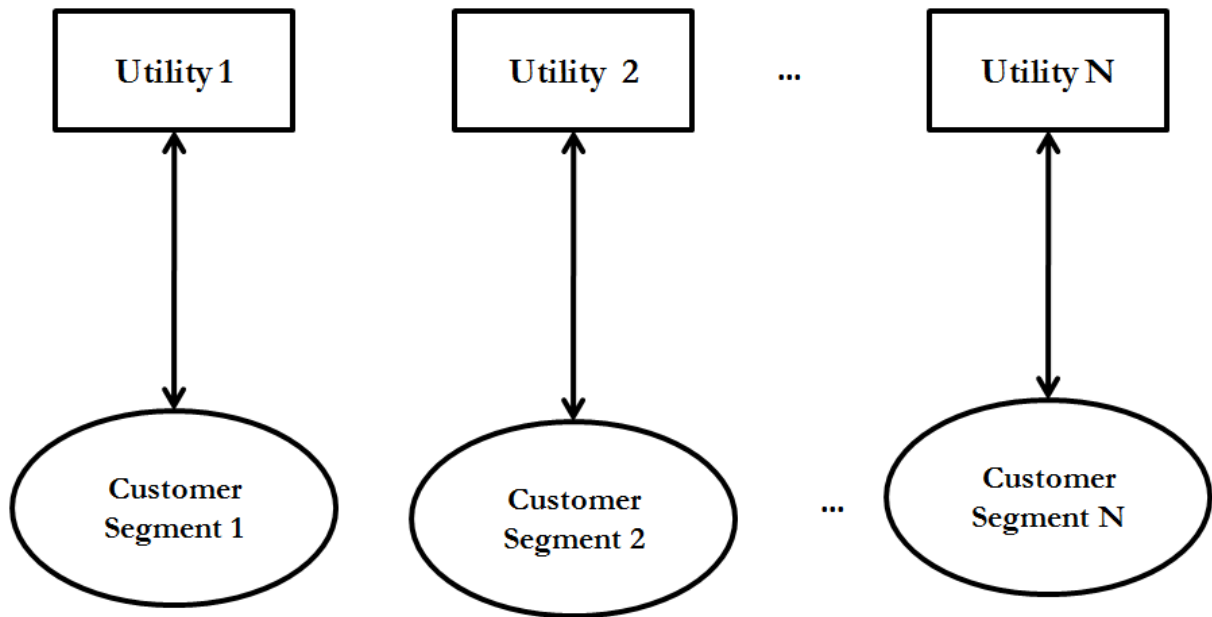

Figure 15: Interactions among Utility Companies and Customer Segments.

4.3.2 The Potluck Problem

The Potluck problem refers to a scenario where people attend dinner regularly and each person decides how much to contribute to the dinner by considering last dinner's supply and demand. There is no coordination among people going to the dinner. The dinner is enjoyable if both there are no leftovers and there is no starvation. Demand for food for an individual varies from time to time depending on the appetite (Totamane *et al.*, 2009; Enumula and Rao, 2010). The Potluck problem is prone to oscillations where there is alternation between starvation and excess food because of rational learning. With rational learning, people will decrease their contributions for next dinner if there was excess food at last dinner and vice versa if there was starvation (Totamane *et al.*, 2009; Enumula and Rao, 2010).

Several predictors with their associated weights and non-rational learning are used to predict demand at future dinner instances and therefore address oscillatory nature of the Potluck problem. Since several predictors are used, a Weighted Majority Algorithm (WMA) is used to determine the overall demand. Weight of correct predictors is increased at each instance while that of wrong ones is decreased. Initially, all predictors have equal (or unequal) weight (Totamane *et al.*, 2009; Enumula and Rao, 2010). In case one prefers to assign unequal

weights, more accurate predictors are assigned more weight and vice versa for less accurate ones.

Various works have used the idea of Potluck Problem to determine demand-supply equilibrium. Maity and Rao (2010), models demand and supply of solar-powered microgrids as Potluck problem, where the residences can act as suppliers and consumers. Work by Singh and Rao (2010) models IT data centres as a Potluck problem with the intention of reducing cost of electricity with Servers as consumers and suppliers. Totamane *et al.* (2009) studies demand and supply of air cargo modelled as a Potluck problem with airlines as consumers and suppliers of air cargo services. In each case, non-rational learning has been used because rational learning leads to oscillation of demand and supply. Potluck problem idea has also been used by Bell *et al.* (2003) and Bell and Sethares (2001). Demand-Supply equilibrium in these works is primarily single-level as it is done on a daily basis, unlike deregulated electricity market where equilibrium need to be achieved on a given day and hour. Moreover, the work by Maity and Rao (2010) seeks to establish a cost-neutral village by addressing per residence demand and supply. This approach may not be scalable to regional and national level to address demand and supply variability.

4.3.3 Application to Deregulated Electricity Market

In a deregulated market, utilities buy electricity at wholesale price from generating companies and sell to consumers at retail price (Joskow, 2008). To model the market as Potluck problem, the utilities are assumed to be suppliers and consumers (through their customers) of electricity. This work intends to establish an optimal position where the supply of electricity at any particular hour is equal to the total demand of electricity at that hour.

In Game Theory terms, the Potluck problem can be classified as a repeated, non-cooperative game in a system where there are both multiple producers and consumers (Totamane *et al.*, 2009). The players (agents) in the game act in order to avoid starvation or excess resource by using historical data. This means no player can benefit from a unilateral move, hence securing a Social Welfare where equilibrium is attained between demand

and supply (Radziszewska *et al.*, 2014). In deregulated electricity market, it is in the interest of ISO to ensure social welfare is achieved at any time slot (game instance).

Suppose there are N utility companies in a given electricity market. These are players in a game. Consider demand and supply of electricity in a given day of a single utility at hour $h \in \mathcal{H} \triangleq \{1, 2, \dots, H\}$, where $H = 24$ hours. Furthermore, consider an instance t (a particular day) of a game at hour h . A player $i \leq N$ has a strategy space $0 \leq Q_i \leq Max_i$, where Q_i is the amount of electricity supplied by player i and Max_i is the maximum amount of electricity that can be supplied by player i . Considering M_i as a set of probability distributions over Q_i which defines mixed strategy for player i ; $S_{i,h,t} \in M_i$ indicates a mixed strategy for player i at game instance t at hour h . Total amount of electricity supplied by players at hour h at t game instance is given by Equation 12. The player makes decision based on the mixed strategy $S_{i,h,t}$ by predicting the total demand of electricity $P_{i,h,t}$ (see Equation 13) at hour h and game instance t . The utilities (players) have been considered to be both producers and consumers of electricity through customers they serve. Therefore, $d_{i,h,t}$ is used to denote demand of electricity of player i at hour h during game instance t . Total demand of electricity for all players at game instance h is as indicated in Equation 13. In this work we seek to establish an equilibrium position where $S_h = D_h$ since if $S_{h,t} < D_{h,t}$ then there will be blackouts and $S_{h,t} > D_{h,t}$ means there is wastage of electricity. Storing excess electricity is expensive and inefficient (Vinois, 2012).

$$S_{h,t} = \sum_i^N S_{i,h,t} \quad (4)$$

$$D_{h,t} = \sum_i^N d_{i,h,t} \quad (5)$$

Since using rational learning in predicting demand results in oscillations; instead, non-rational learning is used where various predictors are used and those providing a correct prediction are trusted more than ones giving wrong predictions. This is natural as experts with correct advice are trusted more than those giving wrong advice. The trust is represented by a certain weight and initially all predictors may have the same weight. Total demand prediction of electricity is obtained by using a weighted average of all predictors. Predictors make use of historical

data about demand and supply of electricity to predict future needs and consumption of it. With electricity, prices as well as demand and supply tend to vary from time to time. In this case, the predictor should make use of past data at a particular hour to predict future demand at that hour. That is, a predictor should be a function that makes use of $S_{h,t-1}, S_{h,t-2}, \dots, S_{h,t-x}$ (past x electricity supply data at hour h) and $D_{h,t-1}, D_{h,t-2}, \dots, D_{h,t-x}$ (past x electricity demand data at hour h) to predict next supply and demand of electricity ($S_{h,t}$ and $D_{h,t}$ respectively) at hour h . In this work, predictors 1-5 have been used as suggested by Maity and Rao (2010), Enumula and Rao (2010) and Totamane *et al.* (2009). Additionally, a new predictor (see item 6) with values comparable to that of item 1 has been introduced.

- (i) Average Predictor (AVP): Predicts demand as the average of all demands of electricity over last x game instances(days) at hour h as shown in Equation 6:

$$AVP = \frac{D_{h,t-1} + D_{h,t-2} + \dots + D_{h,t-x}}{x} \quad (6)$$

- (ii) Random Predictor (RNP): Randomly chooses values for demand of electricity over past x game instances at hour h . Mathematically, RNP is a random variable following the discrete uniform distribution over set $D_{h,t-1}, D_{h,t-2}, \dots, D_{h,t-x}$

- (iii) Rational Predictor (RTP): the demand of electricity at game instance h is the same as one on previous day. Given $D_{h,t-1}, D_{h,t-2}, \dots, D_{h,t-x}$, RTP is calculated as in Equation 7:

$$RTP = D_{h,t-1} \quad (7)$$

- (iv) Maximum Predictor (MXP): Takes largest demand of electricity over last x game instances at hour h (See Equation 8).

$$MXP = \max\{D_{h,t-1}, D_{h,t-2}, \dots, D_{h,t-x}\} \quad (8)$$

(v) Minimum Predictor (MNP): The smallest demand of electricity over last x game instances at hour h (Equation 9).

$$MNP = \min\{D_{h,t-1}, D_{h,t-2}, \dots, D_{h,t-x}\} \quad (9)$$

(vi) MinMaxAverage (NXA): the average of minimum and maximum demand of electricity over x game instances at hour h . Equation 10 indicates how the predictor is obtained:

$$NXA = \frac{MXP + MNP}{2} \quad (10)$$

The predictors (i)-(vi) have been used to compute predicted demand, $P_{i,h,t}$. The Potluck problem with non-rational learning is flexible enough that additional predictors can be added. For instance, a regulator may want to influence demand prediction based on some information not available to utilities by introducing a new predictor to all utilities. Likewise, a time-based predictor (Enumula and Rao, 2010) can be introduced to predict demand according to time of the day, weekdays vs weekends as electricity consumption varies accordingly. Moreover, predictors that take into account explanatory variables such as temperature, calendar events and seasonality would add value to the quality of prediction.

Suppose there are K predictors, each of the N utility companies chooses k ($k \leq K$) predictors randomly or based on some criteria such as computational efficiency and availability. Each utility company has k predictions for demand at game instance t at hour h . Each of the predictions is denoted by $O_{i,p,h,t}$ which refers to the prediction of utility i for game instance t at hour h using predictor p . $O_{i,p,h,t}$ is computed by one of AVP, RNP, RTP, MXP, MNP or NXA. Each predictor is associated with a weight $W_{i,p,h,t}$ which is updated on every iteration of the game. In each step, the weight of accurate predictors is increased (or remains constant) while that of inaccurate ones is decreased. Initially, all predictors have the same non-zero weight. The predictors may also be initialized with some predetermined values or some random values. Using weighted majority, the utility i decides to supply $S_{i,h,t}$ based on demand predicted (i.e. $P_{i,h,t}$) by the k predictors (see Equation 3), taking into account its market share and electricity loss in transmission and distribution lines.

After each hour h , a utility updates the weights of all its predictors depending on their performance in the previous hour, with regard to actual observed demand. It is done by multiplying the weights of predictors by F which denotes a pool of experts, as shown in Equation 12. F depends on two other parameters: β and γ (see Equation 13). As observed by Totamane *et al.* (2009), β is a measure of how drastic predictions change over iterations. Smaller values of β indicates more drastic changes and vice versa is true. That is why in some cases, the algorithm may not converge because of too small values of β , as observed in this work. While β is constant, γ varies depending on the accuracy of predictors as in Equation 14. In Equation 15, the updated weights are normalized so that they are between 0 and 1.

$$P_{i,h,t} = \frac{\sum_{p=1}^k (W_{i,p,h,t} * O_{i,p,h,t})}{\sum_{p=1}^k W_{i,p,h,t}}, p = 1, 2, \dots, k \quad (11)$$

$$W_{i,p,h,t+1} = W_{i,p,h,t} * F \quad (12)$$

$$F = \beta^\gamma, \text{ where } 0 < \beta < 1 \quad (13)$$

$$\gamma = \begin{cases} \frac{O_{i,p,h,t}}{D_{h,t}} & \text{if } \frac{O_{i,p,h,t}}{D_{h,t}} > 1 \\ \frac{D_{h,t}}{O_{i,p,h,t}} & \text{, otherwise.} \end{cases} \quad (14)$$

$$W_{i,p,h,t+1} = \frac{W_{i,p,h,t+1}}{\sum_{p=1}^k W_{i,p,h,t+1}} \quad (15)$$

4.4 Proposed Algorithm

Based on description of the Potluck Problem and non-rational learning algorithm in Section 4.3.2, Algorithm 1 was developed. Every utility company runs the algorithm independently. It is assumed all utilities are connected to both electric grid and communication network. Past data

on demand and supply are accessible to all utility companies and are the same (see Algorithm 1 for more details). The algorithm can be summarized in steps as follows:

- (i) For each day and hour, each utility company selects predictors to be used.
- (ii) Using past data on demand, supply and chosen predictors, the utility predicts demand using each of the predictors.
- (iii) The utility predicts aggregate demand using all predictors with WMA.
- (iv) Based on predicted aggregate demand, the utility decides on total supply and on what it should supply taking into account possible transmission and distribution line losses and its market share.
- (v) Checks actual demand and supply experienced at that hour.
- (vi) Updates weights of predictors based on actual demand and supplied experienced on that hour.
- (vii) Update past data with actual demand and supply.

Algorithm 1: Demand Prediction Algorithm for Multiple Utilities Electricity Market

input : Past x electricity demand and consumption data at a particular hour. That is, $S_{h,t-1}, S_{h,t-2}, \dots, S_{h,t-x}$ and $D_{h,t-1}, D_{h,t-2}, \dots, D_{h,t-x}$.

output: Predicted electricity demand at hour h for utility i and new weight for chosen predictors.

```
1 Initialize  $\beta$ ;  
2 Initialize number of utilities  $N$ ;  
3  $H \leftarrow 24$ ;  
4 Initialize the weight of  $K$  Predictors (e.g.  $W_{i,p,h,t} \leftarrow 1$ );  
5 for  $h \leftarrow 1$  to  $H$  do  
6   Retrieve past  $x$  data on Supply( $S_{h,t-1}, S_{h,t-2}, \dots, S_{h,t-x}$ ) and Demand  
   ( $D_{h,t-1}, D_{h,t-2}, \dots, D_{h,t-x}$ ) of electricity at hour  $h$ ;  
7   for  $i \leftarrow 1$  to  $N$  do  
8     Select  $k$  predictors at hour  $h$ ;  
9     for  $p \leftarrow 1$  to  $k$  do  
10      Compute  $O_{i,p,h,t}$  ;  
11       $P_{i,h,t} \leftarrow \frac{\sum_{p \leftarrow 1}^k (W_{i,p,h,t} * O_{i,p,h,t})}{\sum_{p \leftarrow 1}^k (W_{i,p,h,t})}$ ;  
12      Estimate  $S_{h,t}$  based on  $P_{i,h,t}$ ;  
13      Utility  $i$  decide on  $S_{i,h,t}$  based on estimated  $S_{h,t}$ ;  
14      if  $\frac{O_{i,p,h,t}}{D_{h,t}} > 1$  then  
15         $\gamma \leftarrow \frac{O_{i,p,h,t}}{D_{h,t}}$ ;  
16      else  
17         $\gamma \leftarrow \frac{D_{h,t}}{O_{i,p,h,t}}$ ;  
18       $W_{i,p,h,t+1} \leftarrow W_{i,p,h,t} * \beta^\gamma$ ;  
19       $W_{i,p,h,t+1} \leftarrow \frac{W_{i,p,h,t+1}}{\sum_{p \leftarrow 1}^k (W_{i,p,h,t+1})}$ ;  
20   Update Demand and Supply Data;
```

Table 8: Description of Symbols Used

Symbol	Definition
N	Number of Utilities
h	Particular hour
t	Particular day
i	Specific utility company
H	2400hours, or 0000hours
\mathcal{H}	A set of 24 hours in a day
K	Maximum number of predictors
k	Number of chosen predictors.
p	Specific predictor (e.g. AVP, MXP, etc).
β	Constant parameter between 0 and 1 that measures how drastic are changes in predictions.
γ	Determines to what extent a predictor should be penalized or rewarded based on its accuracy.
x	Number of past data available for prediction.
F	Pool of predictors
$D_{h,t}$	Demand at hour h on day t .
$D_{i,h}$	Demand at hour h , to be served by utility i .
D_h	Total Demand at hour h , .
$S_{h,t}$	Supply at hour h on day t .
$S_{i,h}$	Amount of electricity supplied by utility i at hour h .
S_h	Total Supply at hour h .
$W_{i,p,h,t}$	Weight of a predictor p for utility i at hour h for day t .
$O_{i,p,h,t}$	Predicted electricity demand for a specific utility i at hour h , day t .
$S_{i,h,t}$	Particular utility's amount of electricity it is supposed to Supply to customers at hour h , day t .
$d_{i,h,t}$	Particular utility's demand of electricity at hour h , day t
$P_{i,h,t}$	Aggregate Predicted Demand by utility i , at hour h on day t

4.5 Simulation, Results and Discussion

A deregulated electricity market with four (4) utility companies was simulated for twenty five (25) game instances (days). Predictors made use of 10 past consumption patterns at any given hour (i.e. $x = 10$). Hourly demand and supply data from March to June 2016 from Danish electricity market were used to test and analyze the proposed algorithm (Energinet, 2016).

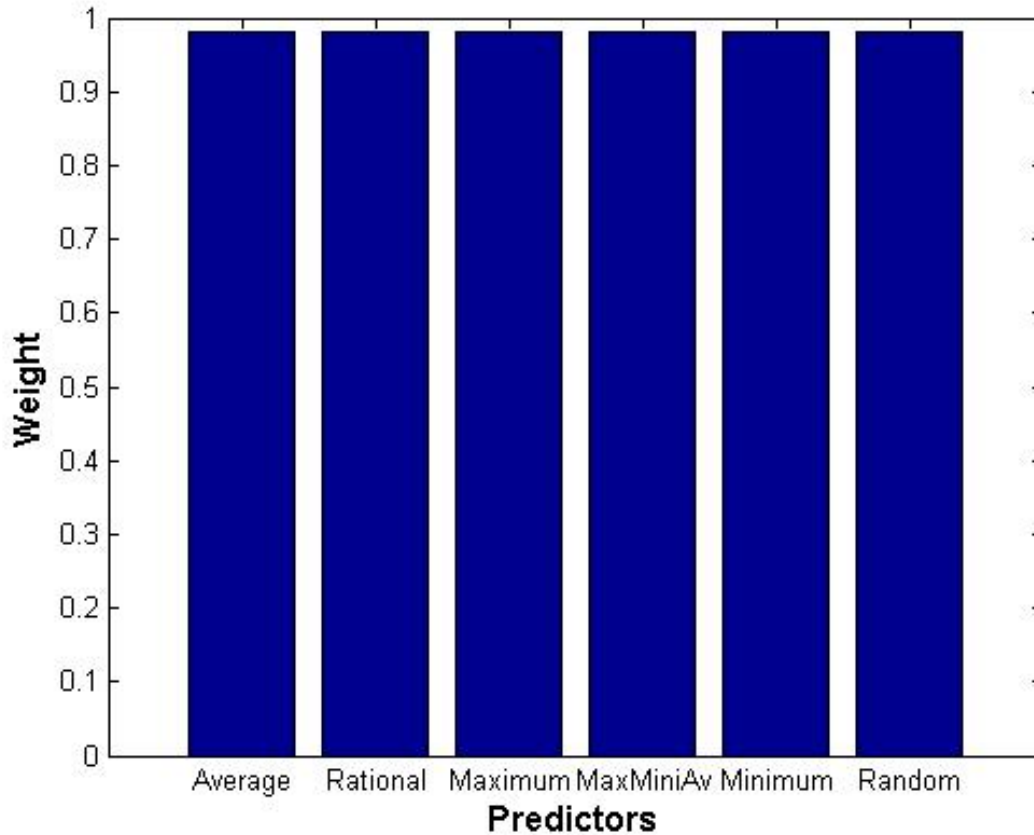

Figure 16: Weight of predictors after convergence.

Six predictors ($K = 6$) have been used in this simulation as discussed in Section 3.3. All predictors had their weight initialized to 1. At each game instance, each utility randomly chose four (4) predictors ($k = 4$). After convergence, all predictors ended up with similar values close 0.9 as illustrated in Fig. 16. Final weights are smaller than initial ones because predictors get penalized when predicted demand is different from the actual ones. In some cases, one may want to assign different weights to predictors, for example AVP is more representative of consumption pattern as it makes use of all past data.

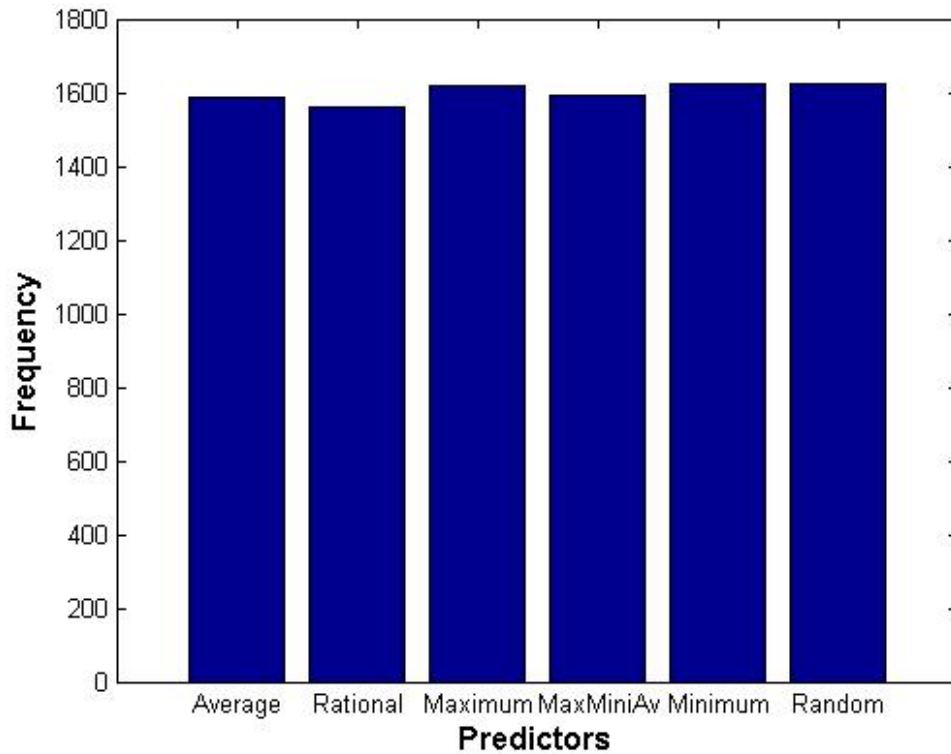

Figure 17: Frequency of use of each predictor

It is reasonable to assign more weight to it. If weights assigned previously are not the same, the final ones may also not be the same, depending on the performance of the predictors. Since the predictors were drawn at random at each hour and for each utility, their frequency of use may differ from time to time as shown in Fig. 17.

Although β values in the range 0 to 1 (exclusive) have been suggested, the system converges for $0.9 \leq \beta < 1$. Otherwise, the system diverges. The proposed algorithm was simulated with parameter $\beta = 0.996$. It was observed that the resulting system started to converge on the 12th instance of the game with all utilities ending with roughly the same demand value at a particular hour as indicated in Fig. 18. This is because the algorithm takes some time to learn the usage patterns, which means the algorithm can be separated into training and learning parts so that utilities converge right away.

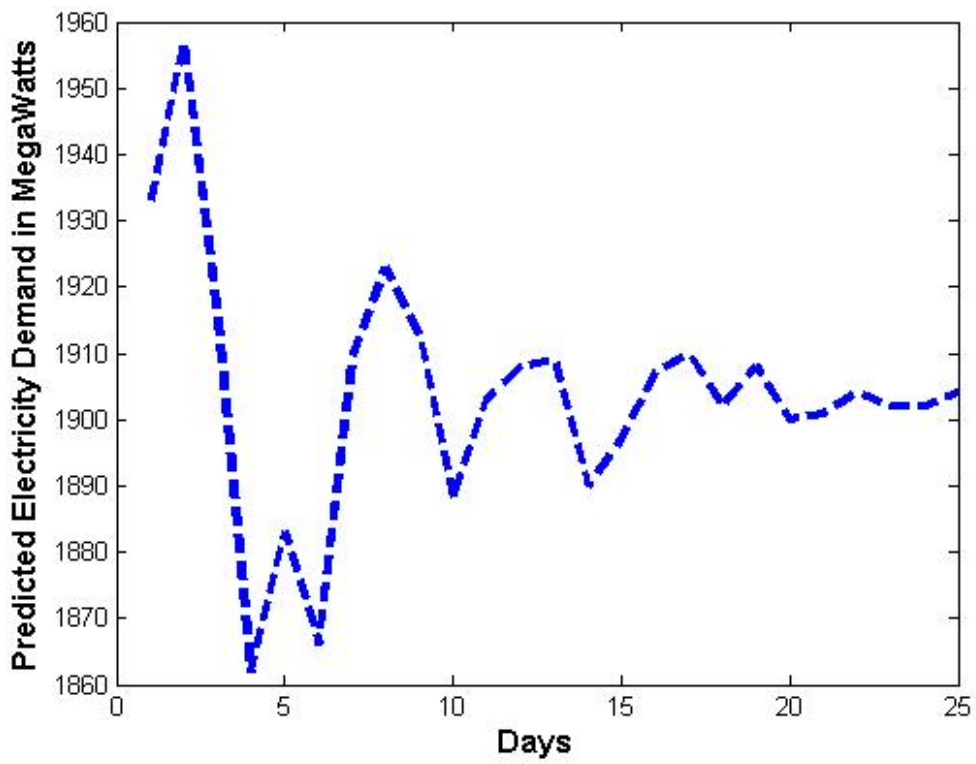

Figure 18: Convergence of a single utility at 0200 hours

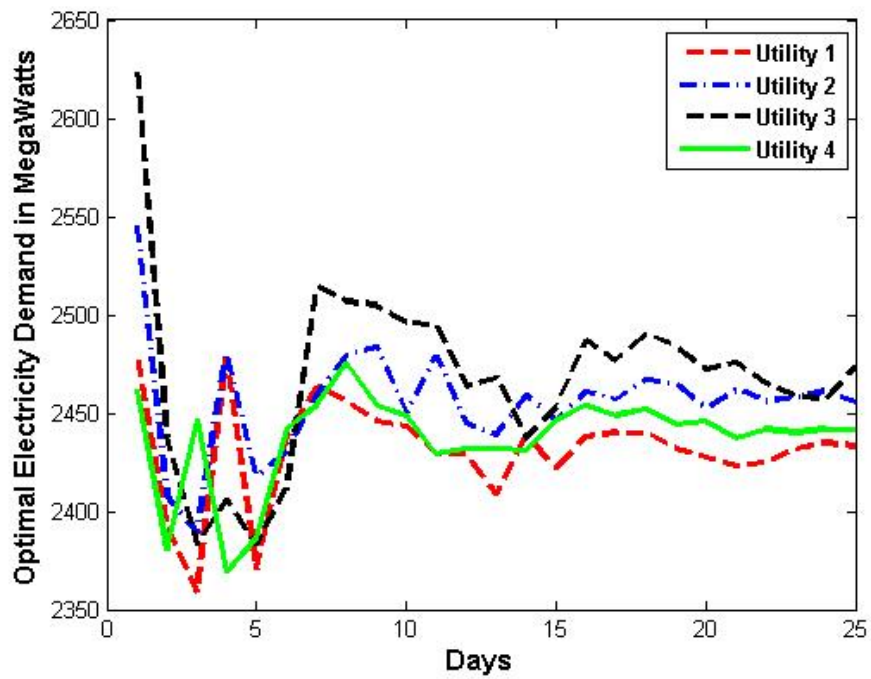

Figure 19: Convergence of four utilities at 2200 hours

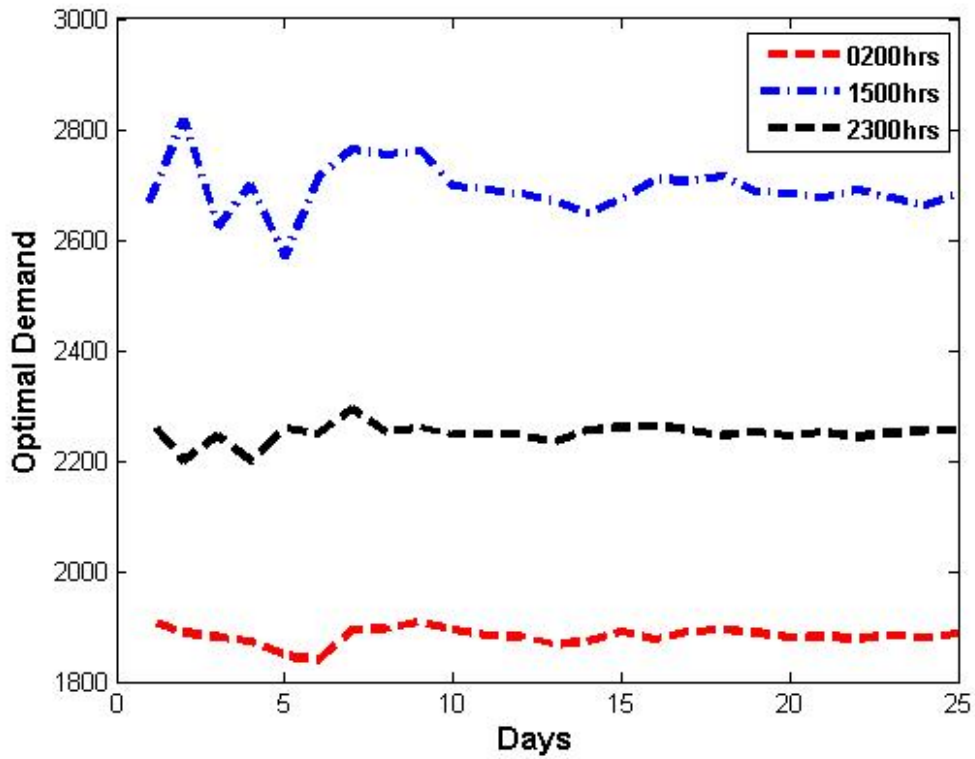

Figure 20: Convergence at different hours for a single utility

Figure 19 indicates convergence of all four utilities at 2200 hours. It can be observed that although utilities may pick different predictors, they all end up with the same or similar demand. Figure 20 illustrates optimal demand at different hours for a single utility, indicating that as the system learns about consumption behaviour, predictions get steady.

Figure 21 provides a contrast between Actual Demand and Optimal Demand. With PAR values of 1.26 for Actual demand and 1.06 for optimal demand (15.87% decrease); it means variability of demand and supply can be reduced using the proposed algorithm as optimal demand gets steady with each game instance. Appendix 5, Appendix 6, Appendix 7 and Appendix 8 (see Appendix section) show actual demand, optimal demand and percentage discrepancy for Utility 1, Utility 2, Utility 3 and Utility 4, respectively. The discrepancy between actual demand and optimal demand can be as small as 0.046% and as high as 33.36%.

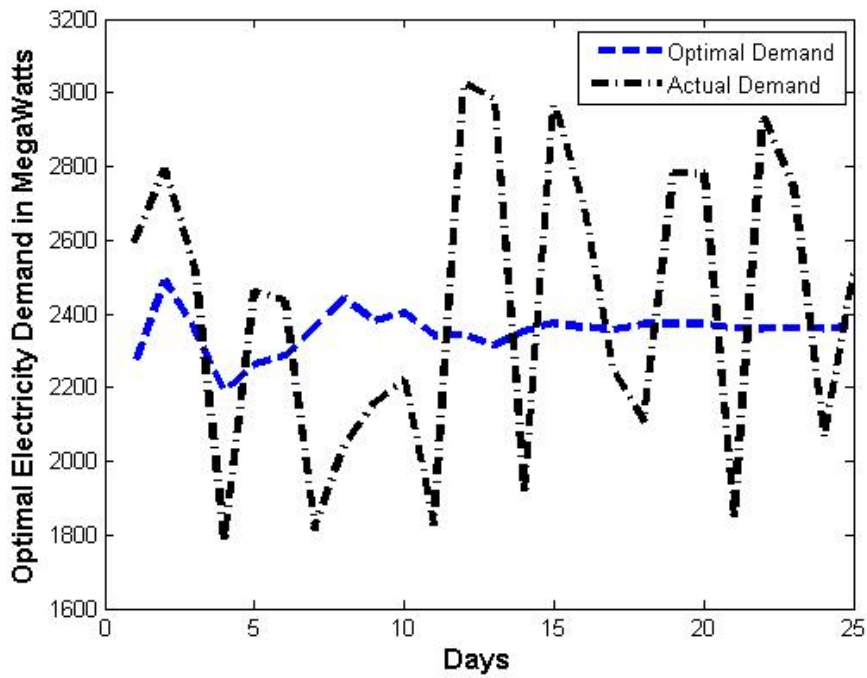

Figure 21: Comparison between actual and optimal demand at 0700 hours

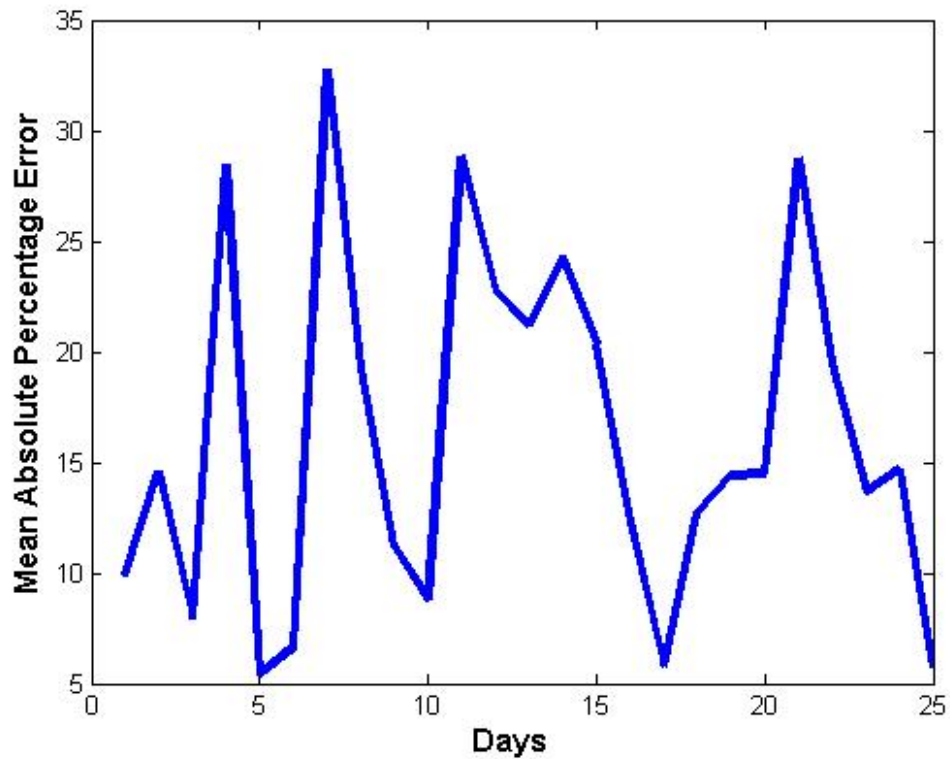

Figure 22: Daily mean absolute percentage error for all four utilities at 0800 hours

Figure 22 indicates Mean Absolute Percentage Error (MAPE) between Actual and Optimal Demand for all 4 utilities. It can be observed that MAPE ranges from 5% to 33%. Although in some cases discrepancy values and MAPE values are significant, what matters is reduction in demand variation while taking into account past consumption patterns as observed in Fig. 21.

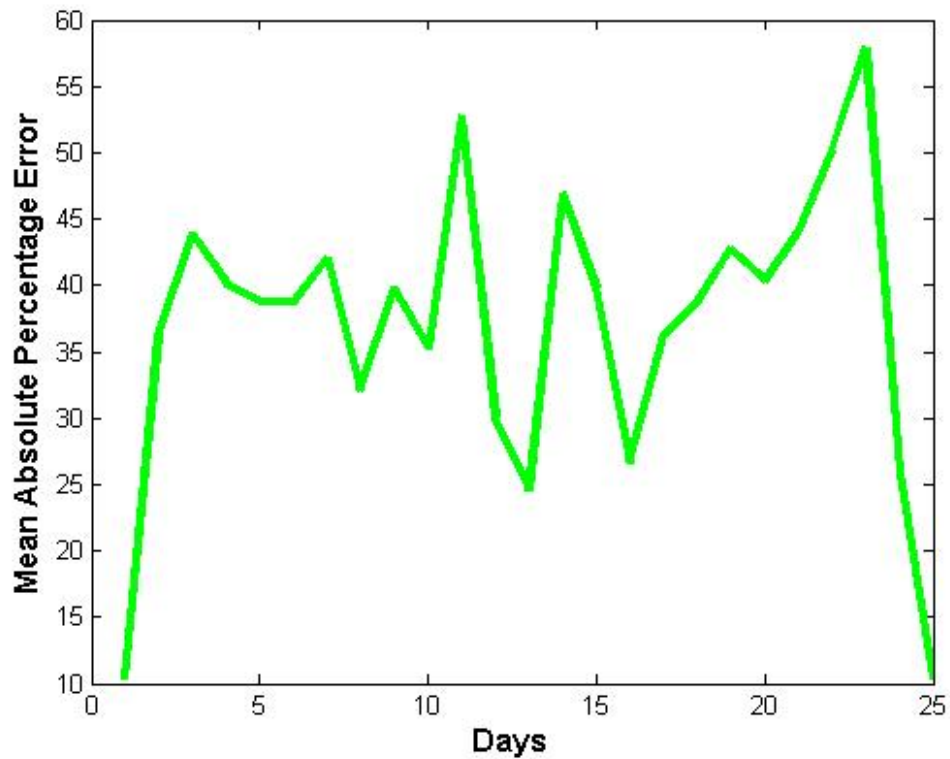

Figure 23: Demand-supply variability with consumers as potluck problem agents

Several works have employed non-cooperative games to model electricity markets (Maity and Rao, 2010; Jalali and Kazemi, 2015; Atzeni *et al.*, 2013b; Soliman and Leon-Garcia, 2014). With the exception of Jalali and Kazemi (2015) and Maity and Rao (2010), most works have assumed single utility company and therefore focuses on the demand-side of the market. In the work by Jalali and Kazemi (2015), multiple utility companies have been taken into account in the supply-side, plus interaction of customers in the demand-side. It is assumed utilities are seeking to make profit and therefore the problem addressed in the supply-side is profit maximization through a bidding mechanism. While utilities may be interested in maximizing profits, the ISO may need to ensure demand and supply matches at all times so as to enhance grid stability and reliability as presented in this work.

The work by Maity and Rao (2010) considers the potential of microgrids in island mode to share excess electricity produced with nearby one. Potluck problem with non-rational learning is used to balance supply and demand with customers acting as both producers and consumers of electricity. Based on residential consumption data from OpenEI (2017), each consumer's optimal demand for every hour was established using demand profiles of 100 000 consumers. Figure 23 illustrates that MAPE for aggregate optimal demand of consumers versus aggregate actual demand varies between 10.4% and 57.9%. Compared with MAPE values obtained in this work (5-33%), it can be argued that modelling utilities as potluck agents rather than consumers is more effective in reducing variability between demand and supply. Moreover, modelling consumers as potluck agents is likely to increase cost of smart meters due to additional processing and memory requirements.

Demand and supply parity on the grid is important so as to avoid wastage of electricity in case there is excess supply and blackouts when there is shortage of it. The proposed algorithm can be used to reduced supply-demand variability without requiring active participation of the customers. Moreover, it is cost effective as it can make use of existing communication infrastructure for sharing historical consumption data.

4.6 Conclusion

Deregulation of electricity markets presents an opportunity for competition among utility companies with a potential for better prices and services to customers. However, it also means that variability of both demand and supply is introduced. In this work, the Potluck problem with non-rational learning has been used to address demand-supply variability problem by predicting optimal demand of electricity at each hour. Active participation of customers to attain the equilibrium (as it is the case in some works) is not necessary. Since deregulated market utilities have customer segments (regions, zones) and do not operate on an entire market; scheduling algorithms can be used with the proposed algorithm for demand side management by enforcing power capacity constraints and encouraging uses to spend more electricity during off-peak hours and reduce consumption at peak hours, resulting in cost savings for both utilities and customers. Power capacity constraints may be established based on optimal demand and

supplies values obtained using an algorithm proposed in this work. The next chapter(Chapter Five), builds on this chapter by proposing a consumption scheduling algorithm that assumes constraints on the available power capacity while guaranteeing each consumer access to shared power.

CHAPTER FIVE

Access Guaranteed Community-based Scheduling Algorithm²

Abstract: Maintaining electric grid reliability is increasingly becoming a challenge because of factors such as significant accommodation of intermittent renewable energy sources into the grid, emergence of new consumption patterns and raising demand worldwide. Sustainable grid reliability cannot be attained solely by increasing generation; Demand-Side Management strategies must be employed. Community-based demand management strategies offer benefits like small implementation costs, improved consumption pattern prediction and flexibility in policy management. However, ensuring guaranteed access for every consumer in the community is a challenge, especially when available power capacity is constrained. In this chapter, we have proposed an algorithm that guarantees access to shared capacity for each consumer in the community in an equitable manner. It has been observed that the proposed algorithm can reduce cost of electricity of the consumer by up to 16.6% while guaranteeing access to shared capacity in an equitable manner. Moreover, utility companies have an opportunity to enhance grid reliability by setting maximum power capacity for each time slot and consumers have financial incentives to adhere to the set capacity.

Keywords: Smart grid, Access guarantee, Token passing, Appliance Scheduling, Community-Based Scheduling, Deregulated Electricity Markets, Demand-Side Management, Residential Automation.

5.1 Introduction

Electricity grids are characterized by periods of low demand (off-peak) and high demand (peak). During off-peak demand, electricity generation is cheap but consumption is low; while during peak demand, generation is expensive and consumption is high. Peak demand normally varies depending on the day of the week, months, weather and climatic conditions. Balancing

² This chapter is based on a published paper titled:

Ngondya, D., Mwangoka, J.(2017). Token Based Scheduling For Access Guarantee in Deregulated Electricity Markets' Smart Grids. *Cogent Engineering*, 4(1), 1394417. <https://doi.org/10.1080/23311916.2017.1394417>,

demand and supply at peak hour is important as oversupply leads to unnecessary running costs for utilities because large-scale electricity cannot be efficiently stored. Moreover, under-supply inconveniences consumers with blackouts and brownouts. Factors such as new consumption patterns as a result of PHEVs, increasing accommodation of intermittent renewable energies to the grid and raising demand makes managing demand-supply parity at peak hours even more important as observed by Anees (2012), Bayar *et al.* (2014), Kamaludin (2013) and Rajeev and Ashok (2014).

Strategies for balancing peak demand and supply include shifting and reducing load. With load shifting, consumers are encouraged (e.g. through pricing) to shift their consumption patterns from peak to off-peak hours in return for some incentives. To reflect actual generation costs, a higher cost may be charged during peak hours than off peak hours, rather than the commonly used flat rates, without necessarily reducing overall consumption. As a result, consumers may be compelled to shift their demand in exchange for potential cost savings.

Load reduction focuses on reducing overall consumption especially at peak hours through energy efficiency programs. In both cases, sharing of pricing and consumption information between utilities and consumers is vital. As observed by Snow and Brereton (2012), people tend to reduce consumption when they have timely information about their usage and pricing. Smart grid-an initiative to equip electricity grids with two-way flow of information from utilities to consumers and vice versa is a promising platform for demand management programs. However, encouraging consumers to shift their loads can lead to new peaks at different hours-also called reverse or rebound peaks (Kishore and Snyder, 2010), again leading to lack of grid reliability. Constant and automatic scheduling of appliances based on maximum demand set by utilities can help deal with both peaks and reverse peaks.

Electricity demand scheduling algorithms are either individual based or community-based. With individual-based schemes, scheduling of appliances is done per residence, while with community-based schemes, scheduling of appliances is done per group (community) of residences. Benefits of community-based versus individual-based include: reduced communication and equipment costs, easier to predict consumption patterns of a given community, flexibility to implement community-wide policies regarding peak

consumption management. However, compared to individual-based approaches, community-based ones raise privacy concerns because they deal with individual loads and not aggregate loads (Derin and Ferrante, 2010).

Most proposed community-based scheduling algorithms assume unlimited power capacity and therefore optimization is based on Load shifting, renewable energy use and storage; as in Alizadeh *et al.* (2012), Bakr and Cranefield (2013), Mediwaththe *et al.* (2015), Negeri and Baken (2012) and Mediwaththe *et al.* (2016). Alternatively, capacity-based algorithms can be explored. With the latter, scheduling of residences is done with respect to a specific maximum power capacity that a utility can supply at a given moment. This is typical of electricity grids in developing countries that are characterized by insufficient generation (Vandaele and Porter, 2015). Equilibrium demand and supply established using the algorithm presented in Chapter 3 may be used to establish constraints for various utility companies in the market. Utilities may then set maximum capacity based on equilibrium demand and supply so that grid reliability is enhanced. Essentially, utilities seek to minimize PAR which is the ratio of maximum demand to average demand in a given day. For example, a constant maximum power capacity for all slots in a day will result in a PAR of 1. The PAR values close or equal to 1 implies a reliable grid while higher values means unreliable grid.

Capacity-based scheduling approach lends itself well to deregulated electricity markets with several utilities, each supplying specific amounts of power at a time. For capacity-based algorithms, equitable and guaranteed access to shared capacity is important. Kishore and Snyder (2010) present a community-based scheduling algorithm that guarantees minimum access to power for each resident. Residences compete for additional power. The algorithm, however, does not take into account guaranteed and equitable access to shared capacity and hence there is a possibility that some residences may not get additional power when they need it even though the maximum power is not reached.

In this chapter, we present a distributed, community and capacity based scheduling algorithm derived from shared medium access control mechanism that has been used in communication networks to ensure equitable access and minimum power guarantee for each residence. Initially, each residence is guaranteed minimum quantity of electricity to consume at each time slot and is guaranteed access to share additional power with other residences in an equitable manner.

While power capacity constraints are desirable for consumption sustainability and reliability, it is likely to pose discomfort to some consumers. It is therefore important to ensure that each consumer has access to shared power capacity. The main contribution of this chapter is development of consumption scheduling algorithm that ensures guaranteed and equitable access to shared power capacity for electricity drawn from the grid.

5.2 Demand Scheduling Approaches

Consumption scheduling requires communication between utilities and customer residences so as to share information. Smart grid provides a framework for sharing information by equipping the grid with bidirectional flow of information, which can be achieved using a palette of communication technologies such as ZigBee, Wireless Mesh, Cellular Network Communication, Digital Subscriber Lines and Power Line Communications (Gungor *et al.*, 2011).

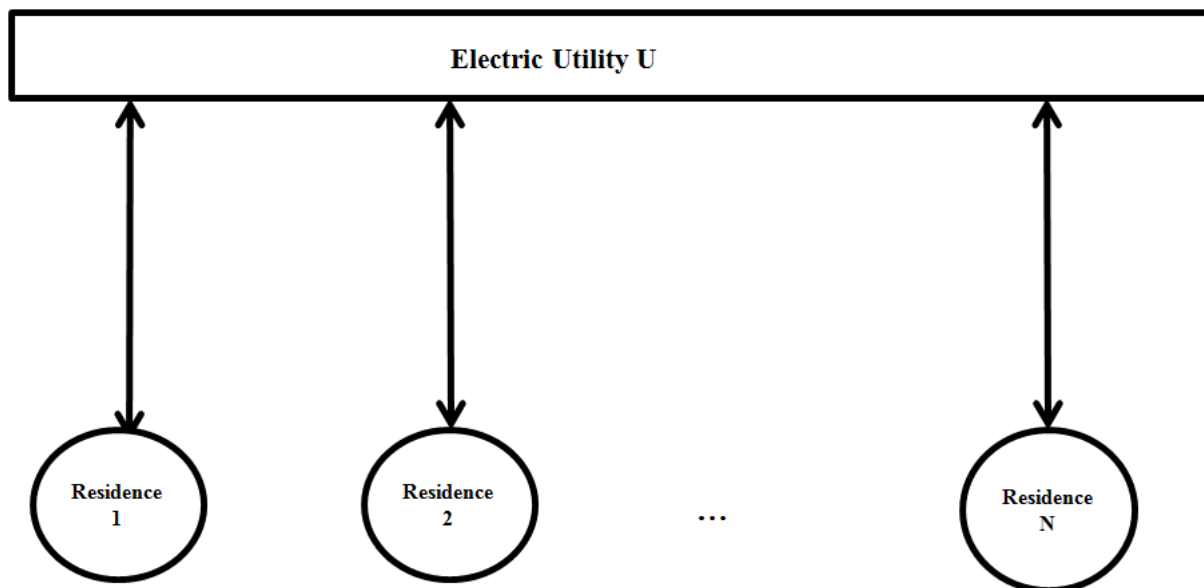

Figure 24: Interaction between Utility company and Individual Residences.

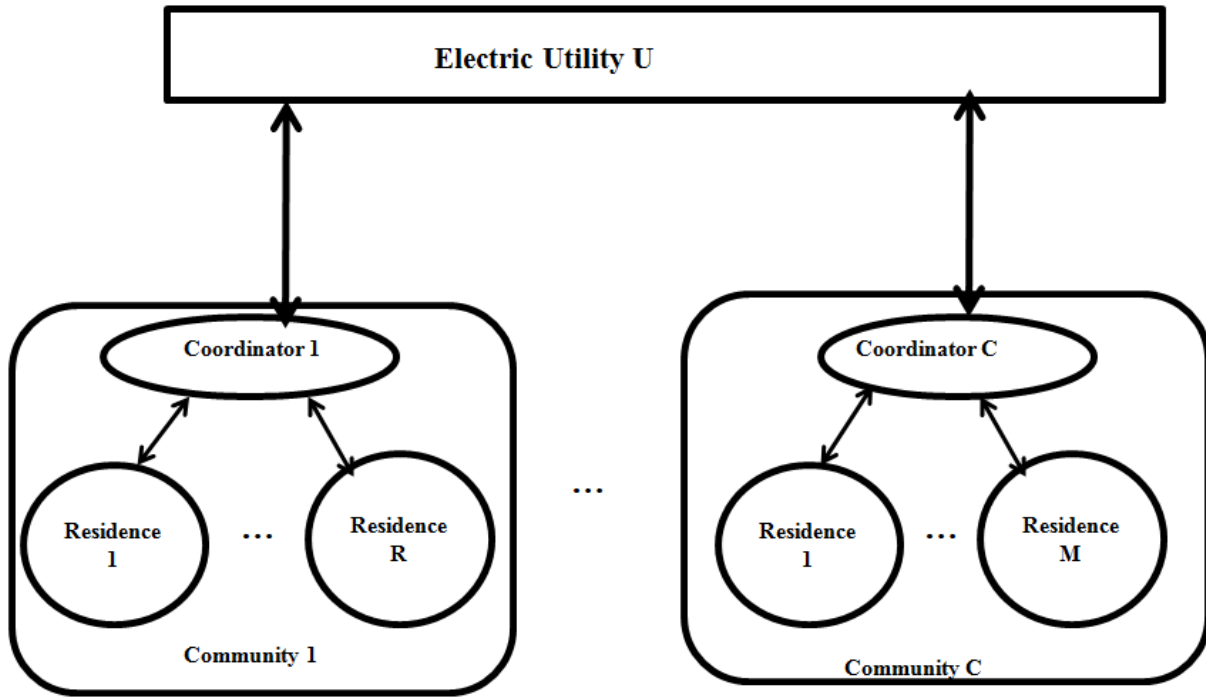

Figure 25: Interaction between Utility company and Communities.

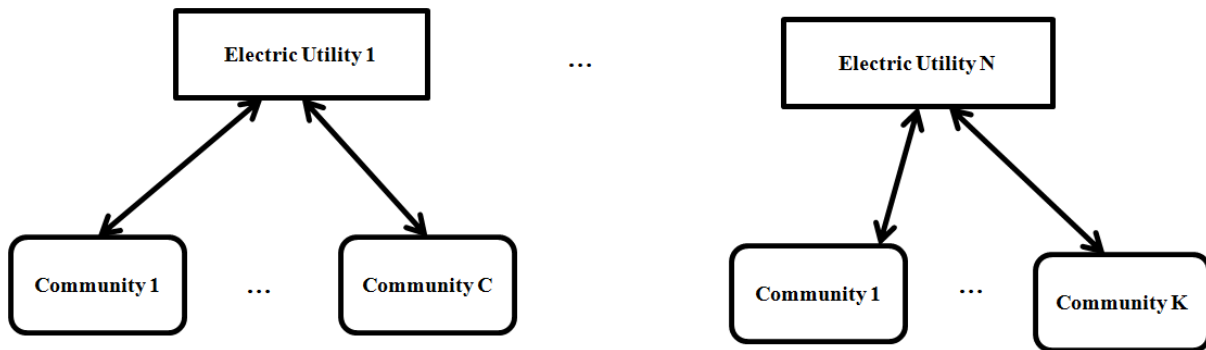

Figure 26: Interactions among multiple utilities and communities in a deregulated market.

For each residence in the community to communicate with particular utility, it must be equipped with a Smart meter, Smart appliances and HEM unit (Javaid *et al.*, 2013). Smart meters provide an interface between a customer residence and utility company or community coordination controller by allowing automatic exchange of consumption information between them. The HEM presents a customer with a user-friendly interface for tracking consumption in detail so that energy optimization decisions can be taken by the user.

The HEM can also provide information regarding generation capacity constraints and storage on a minute-by-minute basis. Smart appliances are networked together and can receive control signals from utilities and customer through HEM (Zipperer *et al.*, 2013). Figure 24 indicates

interaction between particular utility company U with individual customer residences. The interaction is through a Smart meter.

Interactions between utility and communities can be done through a coordination tool housed on a transformer that connects residences in the community to Low Voltage Power Line Network as illustrated by Fig. 25. For deregulated electricity market where multiple utilities interact with various communities, interactions among utilities is as shown in Fig. 26.

Electric loads come into two main categories: Fixed loads and Elastic loads. Fixed loads (e.g., Television, fridge) have strict time and power requirements and therefore are not suitable for scheduling purposes. Elastic loads offer flexibility in starting time and power consumption. Consumption scheduling works by taking advantage of fluctuation in demand and elasticity of certain appliances. Elastic appliances can be classified with regard to time or power. Consumption of appliances such as Washing Machine, Dish Washer, Tumbler Dryer and PHEVs can be shifted in starting time depending on customer flexibility and as such are referred to as time-shiftable appliances. Power-shiftable appliances can have their power consumption adjusted depending on desired level of comfort or optimization needs (Mesarić and Krajcar, 2015; Bakr and Cranefield, 2013; Mehdi and Roshchin, 2015). Heating, Ventilation and Air-Cooling (HVAC) are examples of power-shiftable appliances.

Community-based scheduling has been studied in a number of works (Bakr and Cranefield, 2013; Kishore and Snyder, 2010; Mediwaththe *et al.*, 2015, 2016; Negeri and Baken, 2012). The work by Bakr and Cranefield (2013) present a community-based scheduling algorithm that addresses synchronization problems of individual-based algorithms. The algorithm ensures billing fairness among residences by charging different load profiles differently even if total consumption is the same, hence making it rational for a consumer to participate in demand management scheme. The algorithm enables a customer to reduce electricity bill for time-elastic appliances and flattens demand curve.

Game theoretic and community-based scheduling schemes with centralized energy storage have been studied (Mediwaththe *et al.*, 2015, 2016). Mediwaththe *et al.* (2015) observes that demand forecasting is prone to errors and thereby affecting proposed DSM programs. A dynamic game that is robust to errors and aggregates consumption of all consumers who are allowed to

act in their self-interests while flattening load curve and reducing energy costs is presented. To safeguard the interests of whole community against those of individual consumers, a leader-follower game with benevolent operator is suggested by Mediwaththe *et al.* (2016). The work by Negeri and Baken (2012) proposes a dynamic pricing model to flatten community's variable aggregate demand caused by self-interested customers. The community is assumed to have distributed storage. The pricing model adapts to price responsiveness of self-interested customers using machine learning.

With the exception of Kishore and Snyder (2010), most researches on community-based scheduling have assumed no constraint in generation capacity. This is not the case, especially with electric grids in developing countries that characterized by blackouts and insufficient generation (Brammah and Amponsah, 2012; Kimani, 2008; Sambo *et al.*, 2012). Moreover, deregulation of electricity market allows several utilities to serve customers according to capacity they can purchase from the wholesale market. In Kishore and Snyder's work, a distributed community-based scheduling scheme that guarantees each customer to run basic tasks is presented. If the customer needs additional energy, he/she shares available capacity with the rest of the customers in the community-with random back-off mechanism to schedule energy requests. Every time there are two or more concurrent requests, the customers have to back-off and wait for a random amount of time. With this approach, there is a possibility of some customers to be starved and therefore fail to access additional capacity in a given time slot, even when the maximum limit has not been reached. In this paper, we present a distributed, token based community-based scheduling algorithm that guarantees access to additional capacity for each customer.

5.3 Problem Definition

Consider a community with N residences- each residence connected to the rest through a smart meter or HEM via a communication network. The network can be part of Smart Metering infrastructure or a separate communication network. A Coordinator that can be installed at the Transformer Unit connecting residences to Low-Voltage Network; controls access to communications channel by interacting with HEMs. Scheduling information is exchanged

between the coordinator and HEMs. Suppose H is the number of scheduling slots per day, then energy consumed by particular residence at scheduling slot h is given by l_n^h . If the residence has A smart appliances then l_n^h is given by Equation 16 where $x_{n,a}^h$ is the rated consumption of the appliance. Total energy consumed at slot h in the entire community is given by Equation 17.

$$l_n^h = \sum_{a=1}^A x_{n,a}^h \quad (16)$$

$$L_h = \sum_{n=1}^N l_n^h = \sum_{n=1}^N \sum_{a=1}^A x_{n,a}^h \quad (17)$$

$$\sum_{n=1}^N \sum_{a=1}^A x_{n,a}^h \leq P_{max,h} \quad (18)$$

Cost of electricity is of interest to most customers. Pricing mechanisms such as Flat rate, ToU, RLP and CPP have been used in various electricity markets. ToU pricing divides a day into two or three periods where prices vary, although the prices are the same from day to day. With RLP, prices vary frequently throughout the day to reflect actual wholesale electricity prices in the market. CPP identifies a time of the day when prices may increase dramatically to reflect actual running costs (Barbato and Capone, 2014; Mays and Klabjan, 2016). Unlike ToU, RLP and CPP; Flat rate pricing does not take advantage of actual generation costs that vary from time to time as it charges the same price throughout the day, everyday. Dynamic pricing with ToU, RLP and CPP provide an opportunity to minimize costs on the part of consumers by encouraging them to consume more when price is high, and less vice versa.

Suppose the price of electricity per unit at particular hour is denoted by c_h , then the cost of running an appliance rated $x_{n,a}^h$ is given by Equation 19. The total cost of electricity by user n at time slot h is as indicated in Equation 20.

$$b_{a,n}^h = x_{n,a}^h * c_h \quad (19)$$

$$b_n^h = \left(\sum_{a=1}^A (x_{n,a}^h) \right) * c_h = l_n^h * c_h \quad (20)$$

According to Equation 20, consumers have a chance to reduce their electricity costs by shifting some of their tasks from high to low price periods. If this is done manually, it means consumers will have to keep track of prices throughout the day-which is an inconvenience. Load shifting can also be done automatically using some scheduling algorithm, with consumers only required to set maximum delay, they can tolerate for particular appliance and scheduling slot.

According to work by Kishore and Snyder (2010), cost minimization for appliance a 's request made at time slot h , with maximum allowable scheduling delay d_n is obtained by finding time slot s for which the Equation 21 is minimum. Requests for shared maximum power capacity are random. Also, the duration of time the requested appliance remains on is random. Suppose an appliance is off at time h , the probability that it is requested at time $h + 1$ is denoted by λ_n . The probability varies slightly depending on whether it is peak or off-peak period. In Equation 21, the first term represents cost due to delay in connecting the appliance, with ϕ denoting the delay cost per one time slot. μ_i is the probability that appliance a is on at time slot h and switched off at $h + 1$. The product term determines the probability for the appliance switched on at time slot s will be on at time slot r as the probabilities are independent in each time slot. For $r = s$, the product term is assumed to be equal to 1.

$$f(s) = (s - h) * \phi + \sum_{r=s}^T \left(\prod_{i=s}^{r-1} (1 - \mu_i) \right) x_{n,a}^h * c_h, \text{ for } h \leq s \leq h + d_n \quad (21)$$

5.4 Proposed Consumption Scheduling

To schedule consumption such that it does not exceed maximum power capacity set by a utility, two cases are considered. In the first case, no residence in the community is guaranteed minimum power and in the second case, all residences are guaranteed a certain minimum power depending on size, consumption patterns or some other factors.

5.4.1 Consumption Scheduling without Guaranteeing Minimum Power

With no guarantees for minimum power for a residence, all residences have to share power right from the beginning of the scheduling slot. Sharing of power is done through communication

network connecting all residences in the community. Sharing of power is achieved using a centralized protocol running on the Coordinator and in every HEM in the community. Any residence intending to run an appliance at a given time slot will have to first acquire a token that is managed by the coordinator.

The token is passed from one residence's HEM to another. The token contains instantaneous information about total power consumed by active appliances in the community denoted as $L_{h,i}$ and maximum power capacity $P_{max,h}$ set by utility at a given time slot. A residence with an appliance a (rated as $x_{n,a}^h$) to run first acquires the token and then determines maximum delay (d_n) that the consumer can tolerate in the request. If $d_n = 0$ it means the consumer wants the load to be connected right away. The HEM checks if the appliance can be accommodated into active loads without causing total instantaneous load of active appliances to exceed maximum power capacity set by the utility at specific time slot. If total active load does not exceed maximum power capacity, the appliance is granted access and the token is sent to the next residence. If $d_n > 0$, then HEM computes Equation 21 to determine if there will be cost savings if the load is deferred. If it is possible to reduce cost by deferring the load to scheduling slot later and the maximum power capacity set for that particular slot is not exceeded, then the appliance will be deferred. If deferring does not save cost and maximum power capacity is not reached, then the appliance is connected, otherwise dropped. The algorithm can be made more sophisticated by ensuring that residences that are denied access can be assigned more priority in upcoming scheduling slots. Algorithm 2 represents Consumption Scheduling without Guaranteed Minimum Power.

Algorithm 2: Consumption Scheduling without Guaranteed Minimum Power

input : Appliance Rating, Maximum Delay**output:** Appliance Schedule

```
1 Initialize number of consumers  $N$ ;  
2  $H \leftarrow 24$ ;  
3 for  $h \leftarrow 1$  to  $H$  do  
4   Initialize  $P_{max,h}$ ;  
5    $L_{h,i} \leftarrow 0$ ;  
6   while  $h$  expiry= $false$  do  
7     if Appliance Request= $True$  then  
8       foreach Consumer do  
9         Wait for a Token.;  
10        if Token Received = $True$  then  
11          if  $((x_{n,a}^h + L_{h,i}) \leq P_{max,h})$  then  
12            Optimize  $f(s)$ ;  
13            if  $s = h$  then  
14              Run Appliance at  $h$ ;  
15               $L_{h,i} \leftarrow L_{h,i} + x_{n,a}^h$ ;  
16              Pass the Token.  
17            else  
18              if  $x_{n,a}^h + L_{s,i} \leq P_{max,s}$  then  
19                Run Appliance at  $s$ ;  
20                 $L_{s,i} \leftarrow L_{s,i} + x_{n,a}^h$ ;  
21                Pass the Token.  
22              else  
23                Run Appliance at  $h$ ;  
24                 $L_{h,i} \leftarrow L_{h,i} + x_{n,a}^h$ ;  
25                Pass the Token.  
26            else  
27              Drop the Appliance.;  
28              Pass the Token.  
29        else  
30          Wait for a Token and Pass it.
```

5.4.2 Consumption Scheduling with Guaranteed Minimum Power

Rather than letting all residences share power right from the beginning of scheduling slot, each residence can be guaranteed minimum power $P_{min,h,n}$ for particular slot so that they only compete for additional power. The guaranteed minimum power is set by a utility. Residences have to consume all $P_{min,h,n}$ before asking for additional power to run appliances. $P_{min,h,n}$ can be the same for all residences or it may vary depending on size, number of smart appliances, occupants and past consumption patterns. Machine learning can be used to predict $P_{min,h,n}$ with classifier attributes such as consumption previous day, same time last week, hour of the day, weekdays, weekends, holidays, day of the month and day of the year. In this work, all consumers have been assigned the same $P_{min,h,n}$ values (machine learning was not used to establish the $P_{min,h,n}$ value). The HEM keeps track of 'Local Active Load', denoted by $l_{h,n,i}$, which represents total active load within $P_{min,h,n}$ limits. If there is a new load to connect, HEM checks if it can be accommodated within $l_{h,n,i}$ without exceeding $P_{min,h,n}$. Otherwise, the HEM has to share additional power with the rest of residences in the community.

A token that is managed by the coordinator is used by the residence's HEM to request for additional power. First, HEM checks if maximum allowable (d_n) delay has been set. If $d_n = 0$ it means the consumer wants the appliance connected right away. If $d_n = 0$, next HEM checks if connecting a appliance with rating $x_{n,a}^h$ would not cause total active loads ($L_{h,i}$) in the community to exceed $P_{max,h}$. Connection of the load is granted if $P_{max,h}$ is not exceeded, otherwise the load is ignored and the token is released. If connection is granted, total active load is updated and the token is released. If $d_n > 0$, HEM computes Equation 21 to determine if the load can be deferred so as to save cost and manage peak demand. If the load can be deferred to time slot s , HEM checks if the load $x_{n,a}^h$ cannot cause total deferred load $L_{z,i}$ does not exceed $P_{max,s}$ and deffer the load. Otherwise, the load is dropped. Algorithm 3 illustrates Consumption Scheduling with Guaranteed Minimum Power.

Algorithm 3: Consumption Scheduling with Guaranteed Minimum Power Algorithm

input : Appliance Rating, Maximum Delay**output:** Appliance Schedule

```
1 Initialize number of consumers  $N$ ;  
2  $H \leftarrow 24$ ;  
3 for  $h \leftarrow 1$  to  $H$  do  
4   Initialize  $P_{max,h}$ ;  
5    $l_{h,n,i} \leftarrow 0$ ;  
6    $L_{h,i} \leftarrow 0$ ;  
7   while  $h$  expiry=false do  
8     if Appliance Request=True then  
9       if  $((x_{n,a}^h + l_{h,n,i}) \leq P_{min,h,n})$  then  
10        Connect the Appliance;  
11         $l_{h,n,i} \leftarrow l_{h,n,i} + x_{n,a}^h$ ;  
12      else  
13        foreach Consumer do  
14          Wait for a Token.;  
15          if Token Received =True then  
16            if  $((x_{n,a}^h + L_{h,i}) \leq P_{max,h})$  then  
17              Optimize  $f(s)$ ;  
18              if  $s = h$  then  
19                Run Appliance at  $h$ ;  
20                 $L_{h,i} \leftarrow L_{h,i} + x_{n,a}^h$ ;  
21                Pass the Token.  
22              else  
23                if  $x_{n,a}^h + L_{s,i} \leq P_{max,s}$  then  
24                  Run Appliance at  $s$ ;  
25                   $L_{s,i} \leftarrow L_{s,i} + x_{n,a}^h$ ;  
26                  Pass the Token.  
27                else  
28                  Run Appliance at  $h$ ;  
29                   $L_{h,i} \leftarrow L_{h,i} + x_{n,a}^h$ ;  
30                  Pass the Token.  
31            else  
32              Drop the Appliance.;  
33              Pass the Token.  
34          else  
35            Wait for a Token and Pass it.
```

5.5 Numerical Study

A 10 residences community ($N = 10$) has been simulated using Con Edson's actual ToU rates for New York City, charging $c_h = \$0.21/kWh$ from 1000 hours to 2200 hours and $c_h = \$0.014/kWh$ for the rest of the times Belson (2008). Each residence is assumed to have three schedulable appliances with operating parameters indicated in Table 9 (Kishore and Snyder, 2010). $Max\lambda_n$ and $Min\lambda_n$ denote probabilities that appliance that is off at time h will be requested at time $h + 1$ for peak and off-peak periods, respectively. Moreover, maximum power for each scheduling slot is assumed to be 40.0 kWh and minimum guaranteed load for each customer is 4.0 kWh as in Kishore and Snyder (2010).

Table 9: Simulation Parameters

Values	Washer	Dryer	Heater
c_n	1.8	3.4	5.0
d_n	6	4	2
ϕ_n	0.1	0.25	0.4
$Min\lambda_n$	0.01	0.0392	0.0952
$Max\lambda_n$	0.0704	0.1193	0.2078
μ_i	0.283	0.632	0.865

We first consider the case when there is no guaranteed minimum load for each customer and maximum power for each hour of 40.0 kWh. Figure 27 shows total active load in the community cannot exceed the maximum power capacity set by the utility. Figure 28 indicates how often each customer gets an opportunity to connect their appliances so as to access shared maximum load using proposed token-based algorithm. The figure indicates access before, during and after peak period. In each case it can be observed that all customers have access to shared capacity at least once. Figure 29 shows hourly costs for the entire community. Costs are higher during peak hours than off-peak hours.

Furthermore, consumers have an opportunity to save money on their bills if the defer using electricity until off-peak hours. Consumers can save up to 16.6% of their bills. The proposed algorithm schedules all deferred load to run at 2300 hours, immediately after peak hours as shown in Fig. 31 and Fig. 32. Scheduling all deferred load to run right after peak period would have caused a reverse peak if it was not for the maximum load imposed at each hour. Figure 30 and Fig. 31 indicates ratings of appliances connected before, during and after peak period.

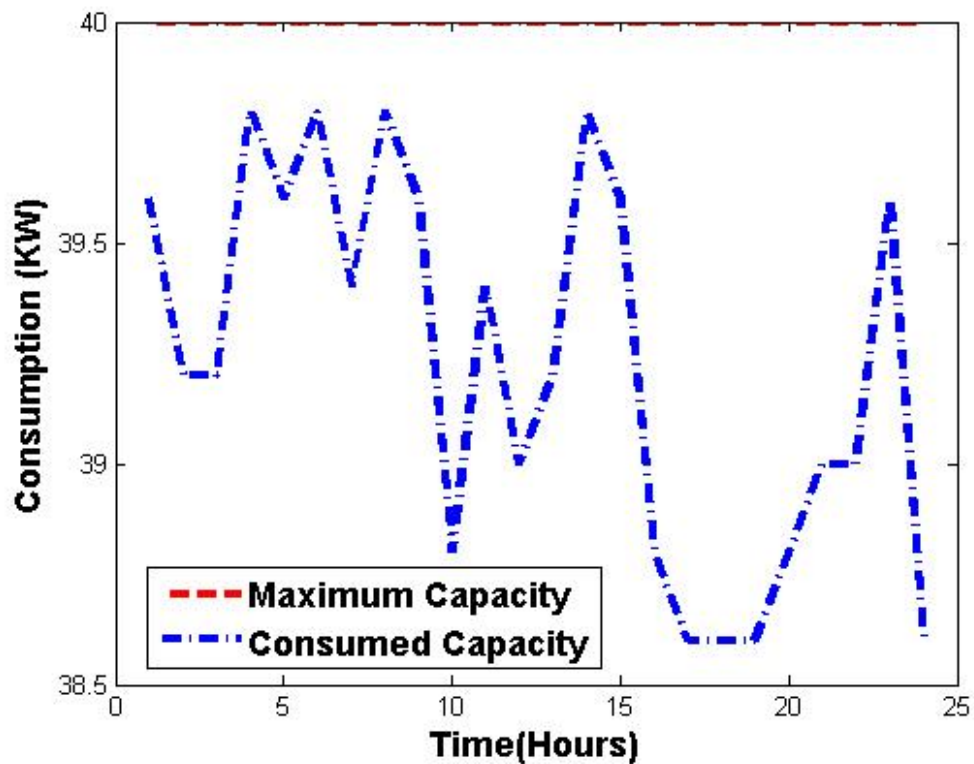

Figure 27: Maximum Power Capacity Constraint

The fact that the appliance with rating 1.8 KW is deferred while the rest are not is compliant with both comfort level settings indicated in Table 9 and ToU off-peak hours. That is, consumers are able to save cost by deferring the appliance with rating 1.8 KW and comfort settings of 6 hours at 1700 hours and it is not possible to save cost with the rest of appliances and their respective comfort settings. Letting consumers share the Maximum Power allocated by utility right from the beginning can be an inconvenience to some as one can only run appliances after receiving a token. We consider the case when each consumer is guaranteed minimum power of 4.0 kWh for each scheduling slot. The consumer is only allowed to share the maximum power capacity after consuming all the 4.0 kWh.

Figure 33 shows that not all consumers have access to the token. This is because consumers who can run their appliances using preset minimum power do not need access to the token. Figure 34 illustrates this point as consumers who did not have access to the token were still able to run their appliances.

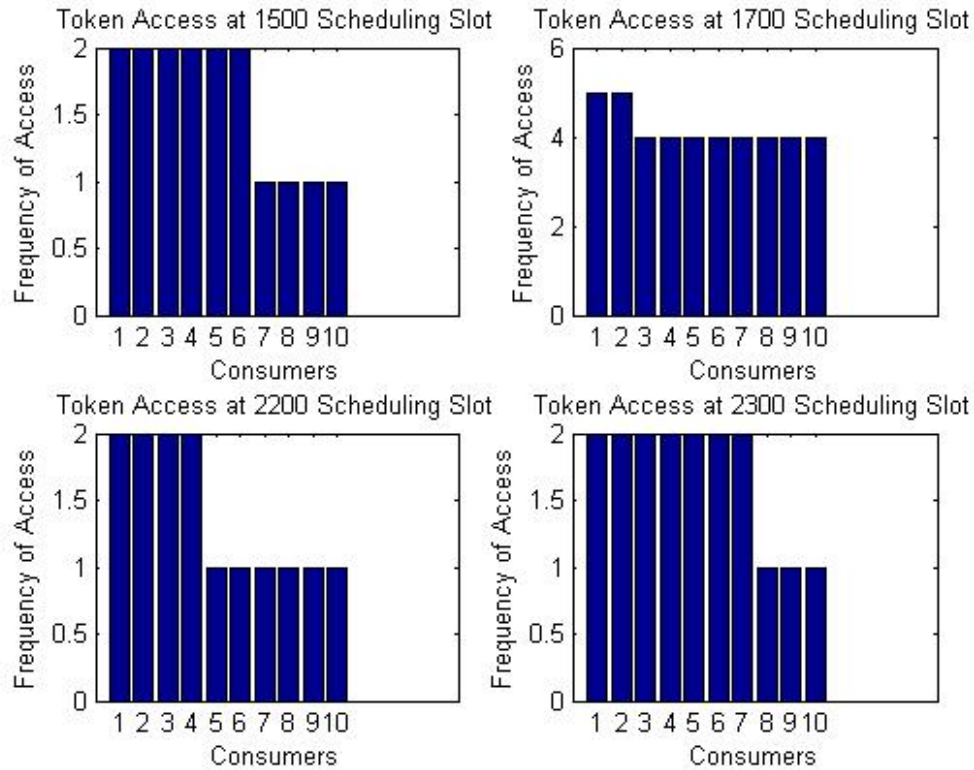

Figure 28: Access to shared maximum power capacity for all consumers with token-based algorithm

Although guaranteeing minimum power for each consumer is more convenient than letting them share maximum capacity right from the beginning, it reduces cost savings as load deferment is only applicable for shared capacity. Cost savings with guaranteed minimum power is on average up to 13.80%, compared to 16.60% savings for the case without guaranteed minimum. This is because guaranteed minimum power is not schedulable and therefore cannot be optimized. It means although not guaranteeing minimum power for each consumer is an inconvenience, it results in more cost savings.

The work by Kishore and Snyder (2010) proposes a community-based scheduling algorithm that employs a random back-off mechanism. Scheduling is done through a common control channel that is used to send and receive information from a coordinating unit. Only one consumer can send request to run appliances at a time. The consumer's HEM only sends requests if the control channel is idle. If two HEMs send their requests at the same time, they have to back-off for a random amount of time. Basically, the algorithm does not guarantee that every consumer will get an opportunity to run appliances.

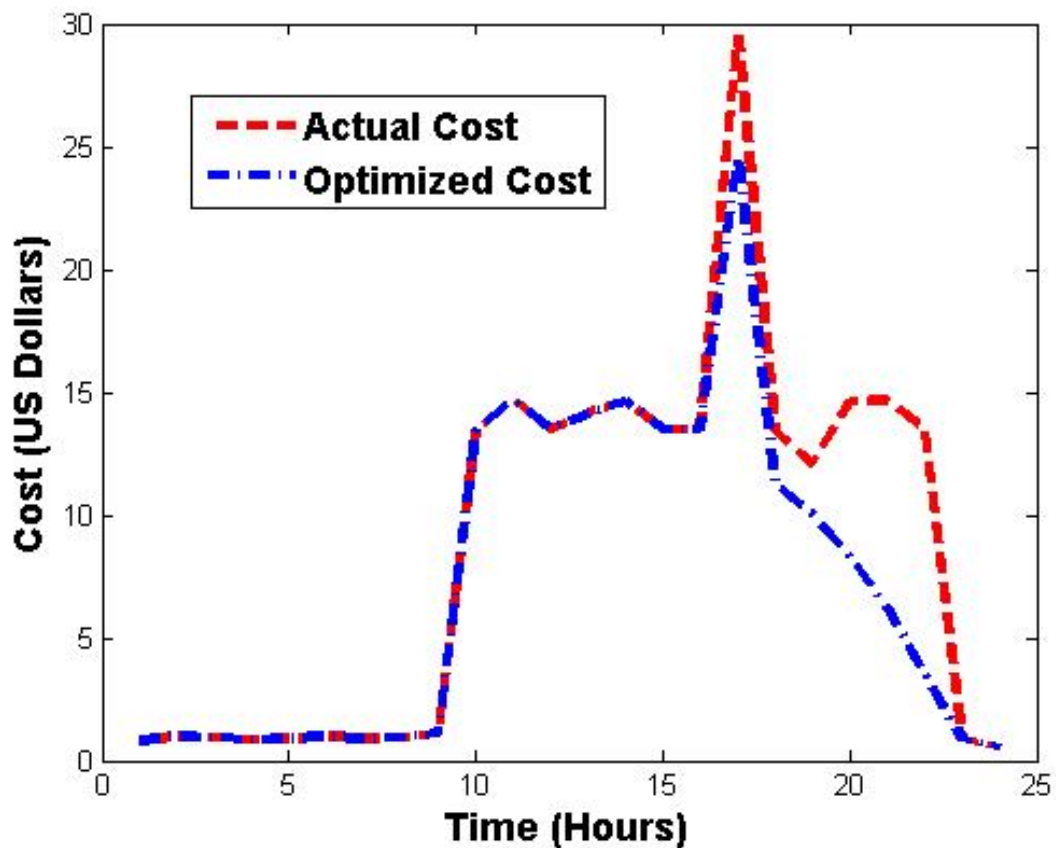

Figure 29: Actual vs optimal Cost

Figure 35 shows access to shared maximum power capacity with no guarantee of minimum power. The figure indicates some consumers lacking access to shared capacity for the entire scheduling slot. Figure 36 indicates access to shared capacity, with all customers guaranteed minimum power capacity. Although some consumers may not have access to shared capacity, they are still able to run appliances because of the minimum power allocated to every consumer. Again, cost savings are reduced (now, only 13.80%) because minimum power capacity is not schedulable.

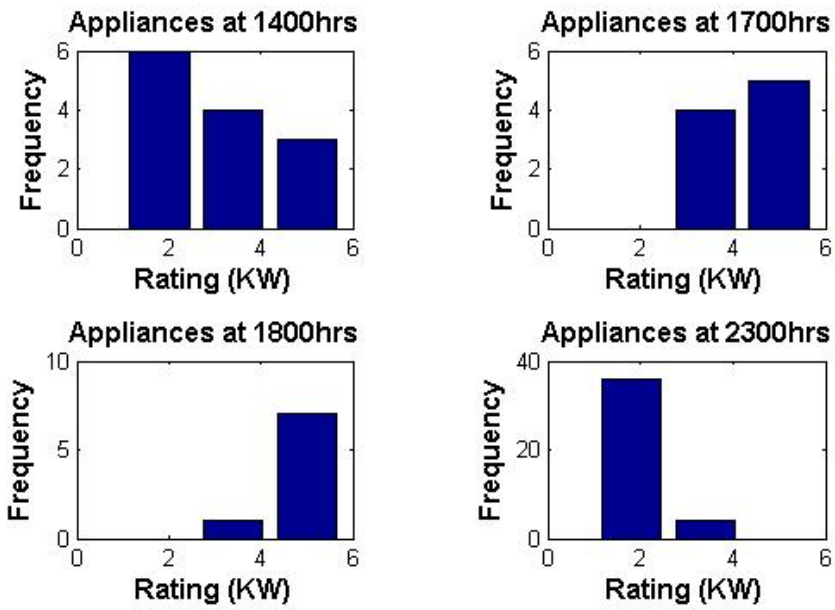

Figure 30: Frequency of connected loads at different Hours

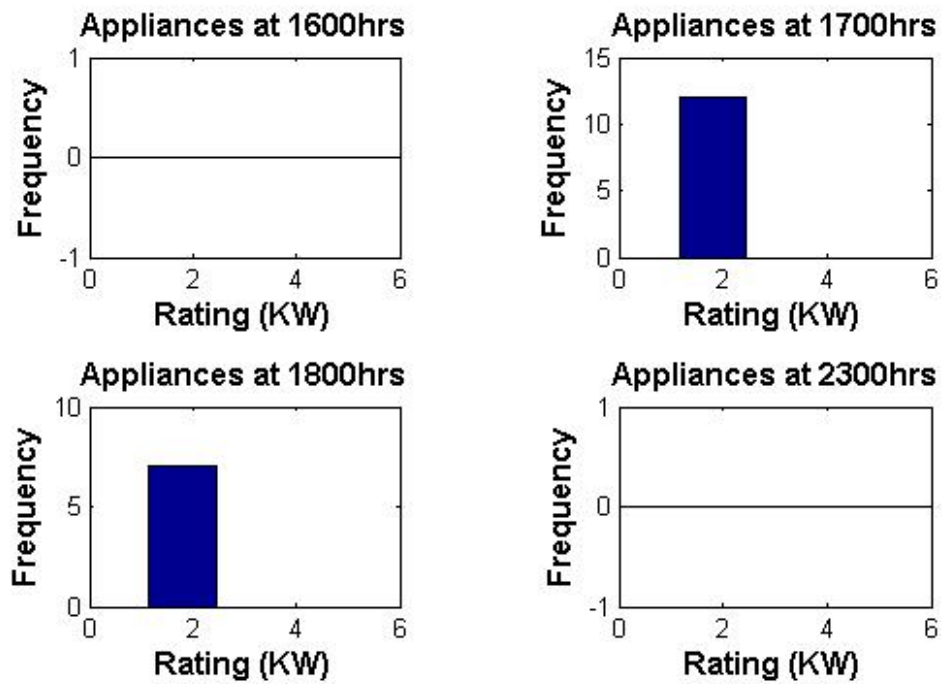

Figure 31: Daily deferred loads

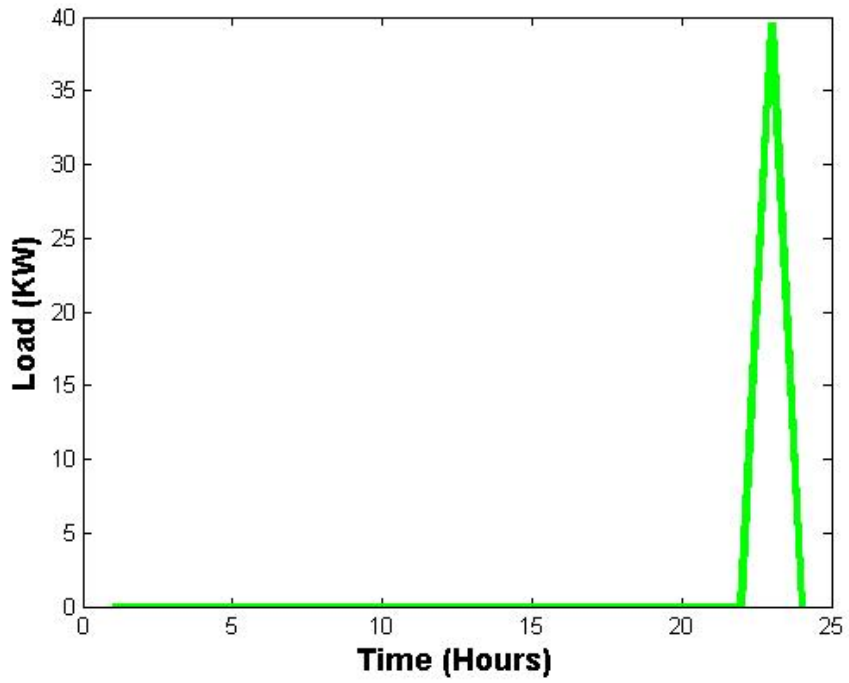

Figure 32: Frequency of deferred loads at various hours

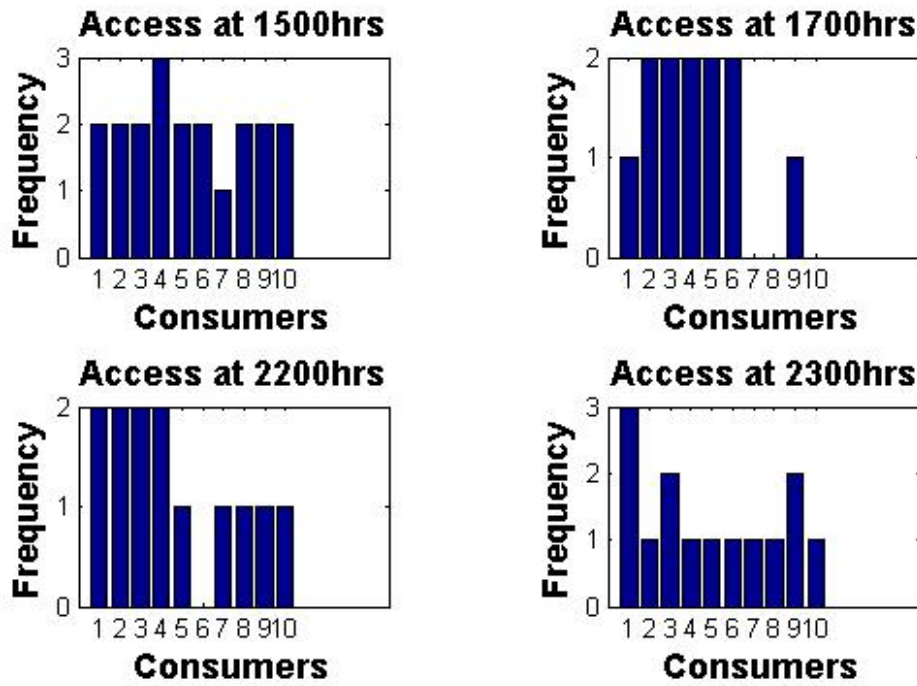

Figure 33: Access to token by various consumers

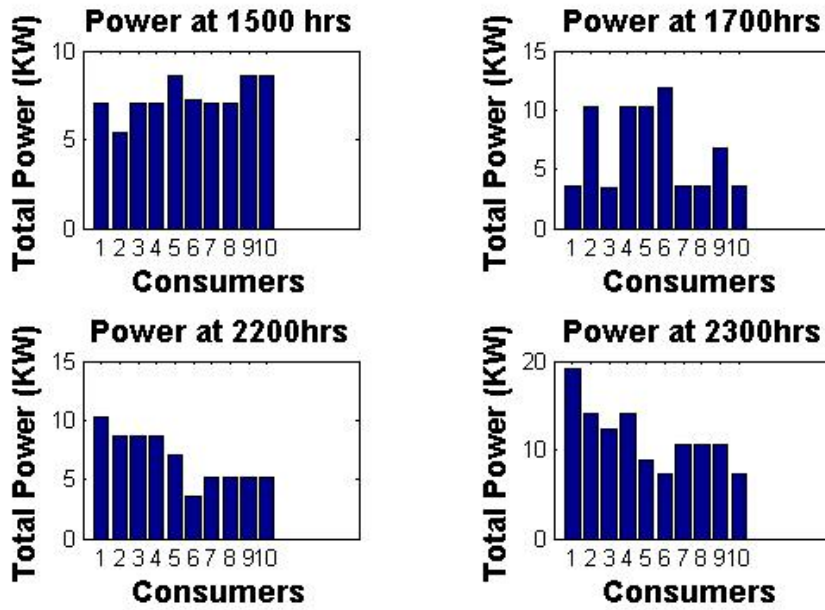

Figure 34: Total consumed power by all consumers

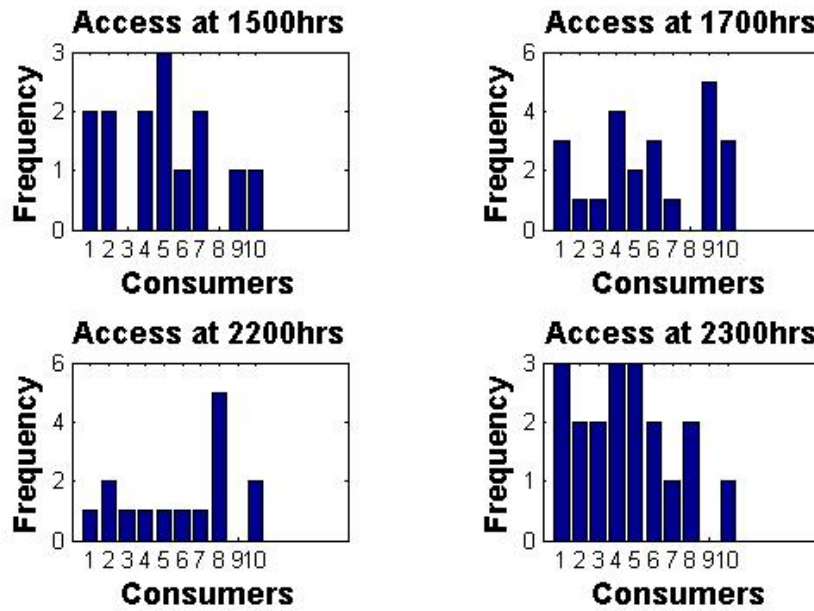

Figure 35: Access to shared power capacity by all consumers with random back-off based algorithm.

Our proposed algorithm guarantees access to shared capacity for every consumer in the community in every scheduling slot, unlike the random back-off mechanism where there are no

guarantees. Moreover, our proposed algorithm leads to more equitable access to shared capacity than it is the case with the random back-off based algorithm as it can be observed from access variance. With no guarantee for minimum power, number of access to shared capacity has variance values ranging from 0.1 to 0.3, while the random back-off based algorithm's variance for the same, ranges from 0.9 to 2.3. Similarly, with guaranteed minimum power for every consumer; the token-based algorithm has variance values ranging from 0.3 to 0.45 while the random back-off based algorithm's variance values ranges from 2 to 4.

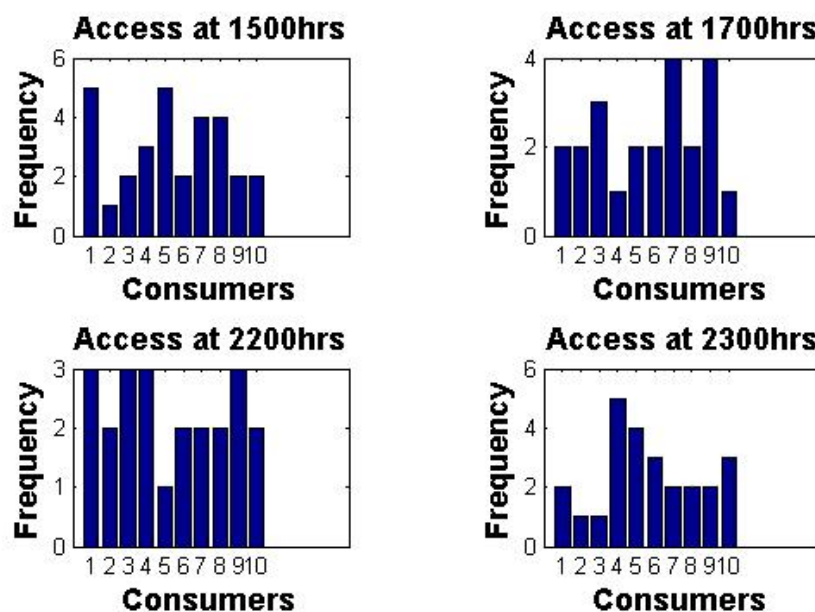

Figure 36: Access to electricity at various hours with each consumer guaranteed minimum power and maximum power capacity shared using random back-off algorithm.

5.6 Conclusion

Community-based scheduling algorithms have an important role to play in DSM, especially when available power is constrained. To ensure support and acceptance of community-based scheduling algorithms by consumers, it is important to ensure guaranteed and equitable access to shared power capacity by all consumers. We have presented an algorithm that guarantees each consumer in the community an opportunity to share the maximum power capacity set by utility. Furthermore, the algorithm ensures access by to the shared capacity is equitable

among consumers and reduces consumers' cost of electricity by up 16.60%. Utility companies can reduce variability in demand by setting maximum power capacity for each scheduling slot and consumers have incentives to adhere to the set capacity and hence attained desired grid reliability. The next chapter (Chapter Six) extends the algorithm proposed in this chapter by incorporating renewable energy sources so as to reduce adverse impacts of scheduling and power capacity constraints such as dropped loads and reverse peaks.

CHAPTER SIX

Access Guaranteed and Green-aware Scheduling Algorithm³

Abstract: Increasing consumption, changing nature of loads and the need to reduce carbon emission are some of the factors threatening electricity grid reliability. Demand side management programs mainly work by shifting consumption from peak to off-peak period, which inconveniences some consumers. Growing use of Photovoltaic solar power in residences provide an opportunity to manage grid reliability in a more flexible manner. We propose a community based scheduling algorithm that guarantees access to shared power capacity and integrates residences' solar power into the grid. Results indicate peak demand can be reduced by up to 32.1%, while energy costs can be reduced by up to 14.0%. Integrating and coordinating GES and storage in the consumer side is crucial to grid reliability.

Keywords: Token Based Scheduling, Demand Side Management, Solar Power, Green Energy.

6.1 Introduction

Traditional Electric Grids are characterized by centralized generation plants, vertically integrated utilities and supply side management of electricity. Traditional grids are showing strains because of recent trends such as deregulation of electricity markets, distributed generation (Haney *et al.*, 2010; Galus and Andersson, 2008), accommodation of intermittent renewable energy sources (Darabi and Ferdowsi, 2011), reduction of air pollution caused by electric grids (Pina *et al.*, 2012), DSM programs and increasing consumption (Sieminski, 2014).

Smart grid is an initiative to address limitations of traditional grids by providing an automated platform for bi-directional flow of electricity and information (Fang *et al.*, 2012). Of main interest to smart grid is DSM of electricity, which provides an opportunity for consumers

³ This chapter is based on a published paper titled:

Ngondya, D., Mwangoka, J.(2017). Access Guaranteed and Green-Aware Token Based Demand Scheduling For Electricity Markets. *Smart Grid and Renewable Energy*, **Submitted: 26 September 2017**

to respond to various signals from utility companies aimed at ensuring grid stability and reliability (Aalami *et al.*, 2010).

Nature of electricity consumption varies greatly depending on whether a consumer is residential, industrial or commercial. The fact that 40% of worldwide consumption is attributed to residential consumers has drawn the interest of many researchers (Haney *et al.*, 2010). Residential DSM programs can be categorized as either individual based or community based. Most DSM programs have focused on individual based solutions where scheduling of appliances is done per single residence, whereas in community based solutions, scheduling is done per group of residences. Growing penetration of GES in residences as observed by Kempener *et al.* (2015) provides additional consumption flexibility that can be employed by DSM programs. However, GES are characterized by intermittency because of varying weather and climatic conditions as observed by Mideksa and Kallbekken (2010). Moreover, storage capacities for energy generated by GES are limited; therefore it is crucial to integrate GES with electricity grid and guarantee access to it for each consumer. In community based DSM programs where power capacity is shared among several residences; guaranteed access to shared capacity is important for consumers' confidence and acceptance of the program. In this paper, we propose a token based green-aware community scheduling program aiming at reducing energy cost while taking consumer comfort into account.

6.2 Related Work

According to Gelazanskas and Gamage, DSM refers to programs that plan, implement and monitor utility activities in order to influence consumer use of electricity (Gelazanskas and Gamage, 2014). DSM programs mainly encourages consumers to shift their consumption from peak demand to off-peak demand through behaviour change and financial incentives. Increasing accommodation of GES into electric grid and residences provides even more flexibility for consumers to embrace DSM programs.

Works by Khan *et al.* (2014) and Meng *et al.* (2013) have proposed DSM programs that encourage consumers to shift their consumption from peak-demand to off-peak demand using price incentives. Price is higher during peak-demand and cheaper during off-peak demand. As

a result, consumers have an opportunity to reduce their bills by shifting consumption from peak-demand to off-peak demand. In study by Khan *et al.* (2014), appliances are modeled as finite state machine and an amount of power that each consumer can access is limited. The proposed DSM program can achieve up to 33.3% peak demand reduction. The work by Meng *et al.* (2013) ensures interests of both utilities and consumers are taken into account when designing prices to encourage shifting of demand from peak-demand to off-peak demand. However, these works do not take into account discomforts that consumers have to face to shift their loads. We consider a case where consumers can flexibly set their preferred waiting time for various appliances.

Consumer cost minimization and comfort have been taken into account in a number of studies as scheduling appliances means possible consumption behaviour change (Bae *et al.*, 2014; Goudarzi *et al.*, 2011; Holtschneider and Erlich, 2012; Khan *et al.*, 2015; Wijaya *et al.*, 2013). Work by Bae *et al.* (2014) establishes similarity in consumption pattern so as to reduce both cost and scheduling discomfort to the consumer. Delay in running of appliances together with cost reduction have been studied by Goudarzi *et al.* (2011). Holtschneider and Erlich have evaluated willingness of consumers to take part in a proposed DSM program that employs fuzzy technology (Holtschneider and Erlich, 2012). The program estimates price responsiveness of consumers to incentives using a rational decision making model. Peak to Average Ratio, cost and waiting time reduction using genetic algorithm have been considered by Khan *et al.* (2014). Work by Wijaya *et al.* (2013) considers PAR reduction while avoiding possible reverse peaks using unequal consumer participation rates. Price fairness is also taken into account. Since shifting peak demand (PAR reduction) is likely to be painful for some consumers, further flexibility can be obtained by tapping into increasing use of GES in residences, especially by encouraging consumers to use their GES during peak demand. The GES benefits include: lower costs in the long run, provides energy security through diversification, easily accessible to consumers and as an alternative to fossil fuels, it helps reduce carbon emissions (Wu *et al.*, 2015).

Demand side management programs equipped with GES and Storage have been considered by Huang *et al.* (2012) and Ruelens *et al.* (2015). Residences with GES and storage have an opportunity to sell excess power generated to the grid using feed-in tariffs. The

tariffs are designed in such a way the utility does not lose out money by setting the selling prices lower than the consumers buying prices. Huang *et al.* (2012) proposes GES and storage to reduce energy cost and scheduling discomfort of the consumer. A disutility function is used to model discomfort and Markov chain based model is used to represent various constraints. The work by Ruelens *et al.* (2015) provides an opportunity for consumers with storage to sell electricity to the grid while taking into account scheduling discomfort. All of these works: Bae *et al.* (2014), Goudarzi *et al.* (2011), Holschneider and Erlich (2012), Huang *et al.* (2012), Khan *et al.* (2014), Khan *et al.* (2015), Meng *et al.* (2013), Ruelens *et al.* (2015) and Wijaya *et al.* (2013) have scheduled appliances per single residence. Scheduling can also be done per group of residences and therefore be able to schedule multiple appliances at once. Scheduling per group of residences is also called community based scheduling. Some of the benefits of community based scheduling include: reverse peaks can be avoided through load synchronization in the community, allows interaction among community members and therefore they can trade with each other excess locally generated electricity and hence avoid transmission losses, system-wide perspective of community programs enable utilities to exploit consumers' appliance usage diversity to manage peak demand (Bakr and Cranefield, 2013; Barbato and Capone, 2014; Negeri and Baken, 2012). Community based scheduling DSM programs have been studied adequately (Bakr and Cranefield, 2013; Kishore and Snyder, 2010; Mediwaththe *et al.*, 2015, 2016; Negeri and Baken, 2012). The work by Bakr and Cranefield (2013) proposes an autonomous and distributed agent-based DSM program that seeks to minimize energy cost while taking into consideration price fairness among consumers. Observing that DSM programs are sensitive to forecasting errors, work by Mediwaththe *et al.* (2015) proposes a DSM program that is robust to forecasting errors by amalgamating consumption of several consumers. Distributed generation and storage are used to reduce scheduling discomfort of consumers during peak hours by Mediwaththe *et al.* (2016). Kishore and Snyder (2010) proposes a DSM program that minimizes consumer cost and waiting discomfort. The program coordinates schedule of appliances in the entire community. Residences in the community share maximum power capacity that is set by a utility. Residences compete for shared capacity using an algorithm based on random back-off mechanism. Most of the discussed community based scheduling algorithms

do not guarantee access to shared capacity for each residence, this increases resistance of consumers to embrace DSM programs. Moreover, power capacity constraints faced by utilities has not been addressed in most of the proposed programs which does not reflect realities in developing countries where there generation capacity is largely inadequate.

In this work, we propose a green-aware token based scheduling algorithm that seeks to reduce energy cost of the consumers. The algorithm relieves consumption shifting discomfort by encouraging consumers with GES to use it during peak demand and those who don't have an opportunity to choose their desired level of comfort by setting their maximum waiting time for appliances. The main contribution of this work is an algorithm that coordinated charging and discharging of storage with solar energy so as to reduce adverse effects of consumption scheduling with capacity constraint, namely: dropped loads and reverse peaks.

6.3 Problem Definition

We consider a community of electricity consumers with N residences, with n representing a particular residence. The community comprises of several nearby residences connected together by a communication network and to the low voltage side of the distribution network. For privacy reasons, it is assumed that there is no directly communication between residences, except through a Coordinator that can be housed at a transformer unit. We assume every residence in the community is equipped with Smart meters, Smart Appliances and HEMU. We further assume some residences have Photovoltaic systems with battery storage as illustrated in Fig. 37.

Smart meters are used to record electricity consumption, exchange information between utility and consumer, manage usage by switching on/off some appliances, track consumption over time and schedule appliances (McDaniel and McLaughlin, 2009). HEMUs provides an interface for a user to track consumption and take necessary optimization decisions. They can also be used to show generation capacity and storage constraints (Zipperer *et al.*, 2013). Smart appliances connect to the smart meter and depending on information received they can shift consumption from peak to off-peak hours (Mohsenian-Rad *et al.*, 2010).

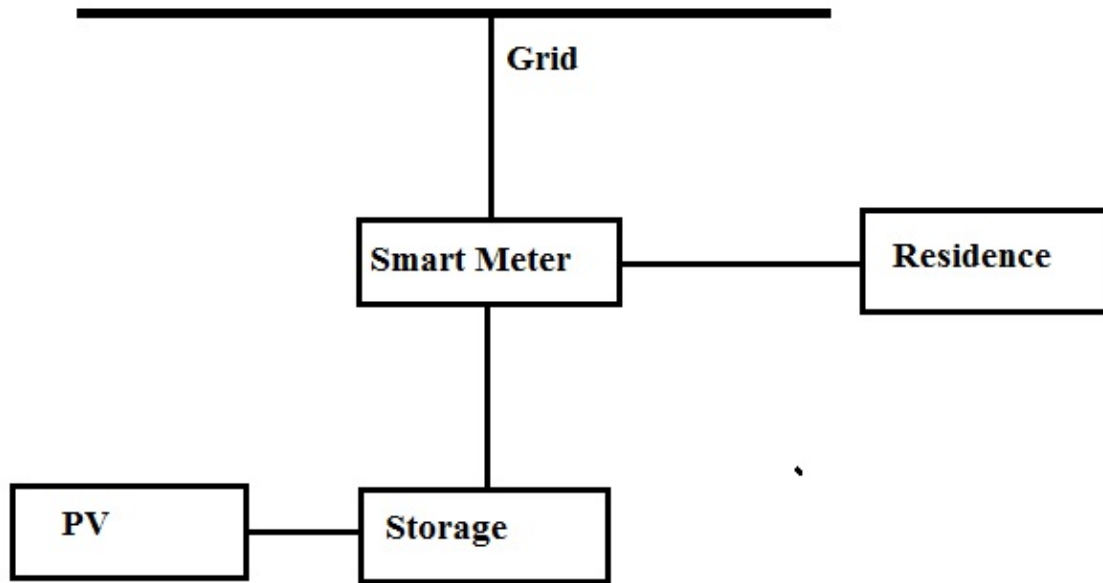

Figure 37: Green-aware system schematic.

Smart appliances can be categorized into two main groups: Fixed and Elastic appliances. Fixed appliances have stringent time and power requirements and therefore cannot be scheduled. Examples of fixed appliances include: Television, Computer, Lights, etc. Elastic appliances are flexible in terms starting time and power consumption. Examples of elastic appliances are: Dishwasher, Washing machine, Dryer and water heater.

Elastic appliances provides an opportunity to schedule them during off-peak demand so as to reduce peak demand. Use of GES and storage during peak hours helps to overcome scheduling discomfort through self-supply. There are many forms of GESs, for instance Solar, wind and geothermal energy sources with various technological approaches. Among different technologies available on the market, Photovoltaic (PV) solar powered generation is the commonest, especially in residences (Hansen *et al.*, 2014). Subsection 6.3.1 to Subsection 6.3.3 models a residence with PV generation and storage.

6.3.1 Solar Power Modeling

Assuming some residences are installed with one or more PV arrays, hourly generated power is as indicated in Equation 22 (Banu and Istrate, 2012; Wu *et al.*, 2015). A term $P_{pv,h}^n$ denotes

hourly power output(in kWh) from consumer n 's PV array(s), η_{pv} is the PV system's efficiency in converting solar energy into electric energy, $I_{pv,h}$ is the hourly solar irradiation-power per unit area received from the Sun in the form of electromagnetic radiation, measured in kWh/m^2 and $S_{pv,n}$ represents the size of the PV array(s) in M^2 .

$$P_{pv,h}^n = \eta_{pv} * I_{pv,h} * S_{pv,n} \quad (22)$$

6.3.2 Storage Modeling

Residences with PV solar system are additionally connected to battery storage so as to store generated power for use during peak demand. It is assumed the battery storage is charged during the day and used (discharged) at night. For each storage in residence n , there are two key constraints that determine how much power can be stored and accessed: minimum capacity $B_{min,n}$ and maximum capacity $B_{max,n}$. In-between the two constraints is the State of Charge (SOC) which varies depending on whether the storage is being charged or discharged (see Equation 26). Hourly SOC of residence n is denoted as $B_{h,n}$. Equation 23 indicates SOC during charging process, where η_c is the charging efficiency. Based on works of Adika and Wang (2014), Bozchalui *et al.* (2012) and Wu *et al.* (2015), we formulate Equation 23 to Equation 25.

$$B_{h+1,n} = B_{h,n} + \eta_c * P_{pv,h}^n \quad (23)$$

$$B_{h+1,n} = B_{h,n} - \frac{1}{\eta_d} * l_{n,h} \quad (24)$$

Equation 24 indicates SOC during discharge process. η_d is the discharging efficiency and $l_{n,h}$ is the hourly load at residence n . Charging and discharging is as indicated in Equation 25. Depth of Discharge (DOD) determines how deeply the storage can be discharged and is bounded between minimum capacity and maximum capacity as indicated in Equation 27.

$$B_{h+1,n} = B_{h,n} + \eta_c * P_{pv,h}^n - \frac{1}{\eta_d} * l_{n,h} \quad (25)$$

$$B_{min,n} \leq B_{h,n} \leq B_{max,n} \quad (26)$$

$$B_{min,n} = (1 - DOD) * B_{max,n} \quad (27)$$

6.3.3 Green-Aware Demand Side Management Model

Suppose a community has N residences, let n denote particular residence. Let there be H scheduling slots in a day, where h represents particular scheduling slot. Let λ_n denote the probability that an appliance that is off at time h is requested at time $h + 1$. Both requests for shared power capacity and duration of time the appliance is still on are random. A schedulable appliance a from residence n sends a request at time slot h to the smart meter to run a load rated $x_{n,a}$ with comfort level $d_{n,a}$. The comfort level represents a maximum amount of scheduling slots that a consumer is willing to wait for the appliance to run. The comfort level of 0 means a user wants the load to be connected right away-no scheduling. To account for green energy and storage, an equation proposed by Kishore and Snyder (2010), is modified such that a decision to run the appliance right away or defer it is done based on Equation 28. If an appliance is turned on at time h , the probability that it will still be on at time $h + 1$ is μ_i . We assume an event that particular appliance is on at time h is independent of the event that the same appliance is on at time $h + 1$.

$$f(s) = (s - h) * \phi_a + \sum_{r=s}^H \left(\prod_{i=s}^{r-1} (1 - \mu_i) \right) (\Delta_{h,n} * c_h + W_{h,n}) \quad (28)$$

In Equation 28, s is the starting time of the appliance, where $h \leq s \leq h + d_{n,a}$. So the first term indicates cost associated with waiting for the appliance to run. ϕ_a is the cost of waiting for particular appliance a . The second term is the expected cost if the appliance is on. $\Delta_{h,n}$ is net electricity consumed from the grid by residence n and its price is c_h . $W_{h,n}$ is the wearing cost of residence n 's the PV system and storage during control period. In Equation 29 and Equation 30; R_n is a binary variable with a value of 0 if a residence has no green energy and 1 otherwise. In Equation 30, q is the storage wearing coefficient and b represents hourly wearing coefficient of other PV components.

$$\Delta_{h,n} = \begin{cases} x_{n,a}, & \text{if } R_n = 0 \\ 0, & \text{if } (B_{h,n} - (\frac{1}{\eta_d} * x_{n,a}) - B_{min,n}) \geq x_{n,a} \\ (x_{n,a} - (B_{h,n} - (\frac{1}{\eta_d} * x_{n,a}))) - B_{min,n}, & \\ \text{otherwise} & \end{cases} \quad (29)$$

$$W_{h,n} = \begin{cases} 0, & \text{if } R_n = 0 \\ \sum_{h=s}^H [q * (x_{n,a} - \Delta_{h,n})] + (H - s) * b, & \\ \text{otherwise} & \end{cases} \quad (30)$$

6.4 Green-Aware Consumption Scheduling

Hourly maximum power capacity is shared throughout a community so as to exploit heterogeneity of consumers to implement a DSM program. Employing a token based algorithm, every consumer is guaranteed to access a token at least once in every scheduling slot. A Coordinator unit housed at a transformer unit manages the tokens. The Coordinator receives price and power capacity constraints information from a utility company and communicates them to the entire community using the token. The token holds information about hourly prices, hourly maximum capacity and hourly instantaneous consumed power.

Consumers in the community need no token to run their fixed appliances, however their loads contribute towards maximum power capacity. For inelastic appliances, consumers can run them directly if they have sufficient stored power; otherwise, they have to wait for the token. Algorithm 4 illustrates an access guaranteed and green-aware token based consumption scheduling Algorithm.

Algorithm 4: Green-Aware Consumption Scheduling Algorithm

input : Appliance Rating, Comfort Level, Maximum Power Capacity

output: Appliance Schedule

```
1 Initialize number of consumers  $N$ ;  
2  $H \leftarrow 24$ ;  
3 for  $h \leftarrow 1$  to  $H$  do  
4   Initialize  $P_{max,h}$ ;  
5    $L_{h,i} \leftarrow 0$ ;  
6   while  $h$  expiry=false do  
7     if ApplianceRequest=True and Maximum Power Capacity Not Reached then  
8       if ApplianceType=Fixed then  
9         Run the Appliance  
10      else  
11        if Stored Power is Sufficient and  $h=Peak$  Time then  
12          Run the Appliance  
13        else  
14          for  $n=1$  to  $N$  do  
15            Wait for Token  
16            Decide whether to Run, Defer or Drop the Appliance Using  
17            Equation 28  
            Pass the Token
```

6.5 Numerical Study

A community with 10 residences ($N = 10$) has been considered. Actual ToU prices from Con Edison-an energy company in New York, has been used (Belson, 2008). ToU pricing used in this work divides a day into two parts: off-peak period (from 2300 hours to 0900 hours) and peak period (1000 hours to 2200 hours).

Price of electricity for off-peak period is $0.014/kWh$, while that of peak period is $0.21/kWh$. It has been assumed 50% of residences in the community have GES and Storage with varying capacities and discharging times range from 1700 hours to 2000 hours. Table 10, Table 11 and Table 12 shows parameters for Elastic appliances (Kishore and Snyder, 2010), fixed appliances (Adika and Wang, 2014) and both PV as used by National Renewable Energy Laboratory (2017) and Leadbetter and Swan (2012) and storage (Wu *et al.*, 2015).

Table 10: Elastic Appliances

Values	Washer	Dryer	Heater
$x_{n,a}$	1.8	3.4	5.0
$d_{n,a}$	6	4	2
ϕ_h	0.1	0.25	0.4
$Min\lambda_n$	0.01	0.0392	0.0952
$Max\lambda_n$	0.0704	0.1193	0.2078
μ_i	0.283	0.632	0.865

Table 11: Fixed Appliances

Appliance	Rating
Television	0.20
Computer	0.35
Indoor Lighting	0.36
Refrigerator	0.50

Table 12: Storage and PV

Parameter	Value
η_c	85%
η_d	100%
DOD	70%
$B_{max,n}$	5 – 8KWh
$I_{pv,h}(\text{Africa})$	1kW/M ²
$S_{pv,n}$	7.6-20.7M ²
η_{pv}	16%

Figure 38 shows each residence's access to shared maximum power capacity at different hours. All residences in the community have access to shared maximum power capacity, regardless of whether they have GES and storage or not. Each residence is guaranteed access to shared capacity at least once during each scheduling slot. Total consumption of GES in the community is shown in Fig. 39.

The proposed algorithm schedules appliances to consume stored power during peak hours only, specifically, starting from 1800 hours. It is assumed charging of the storage happens during daytime, therefore charging and discharging are not happening concurrently. Figure 40 indicates power consumed from the grid which has PAR value of 1.018. Figure 41 shows total consumption of power in the community (green+grid power) with PAR=1.50. From Fig. 40 and Fig. 41 it can be observed that GES and Storage can reduce grid's peak demand by up to 32.1% without entirely relying on shifting consumption and hence reduce energy cost by up 14%.

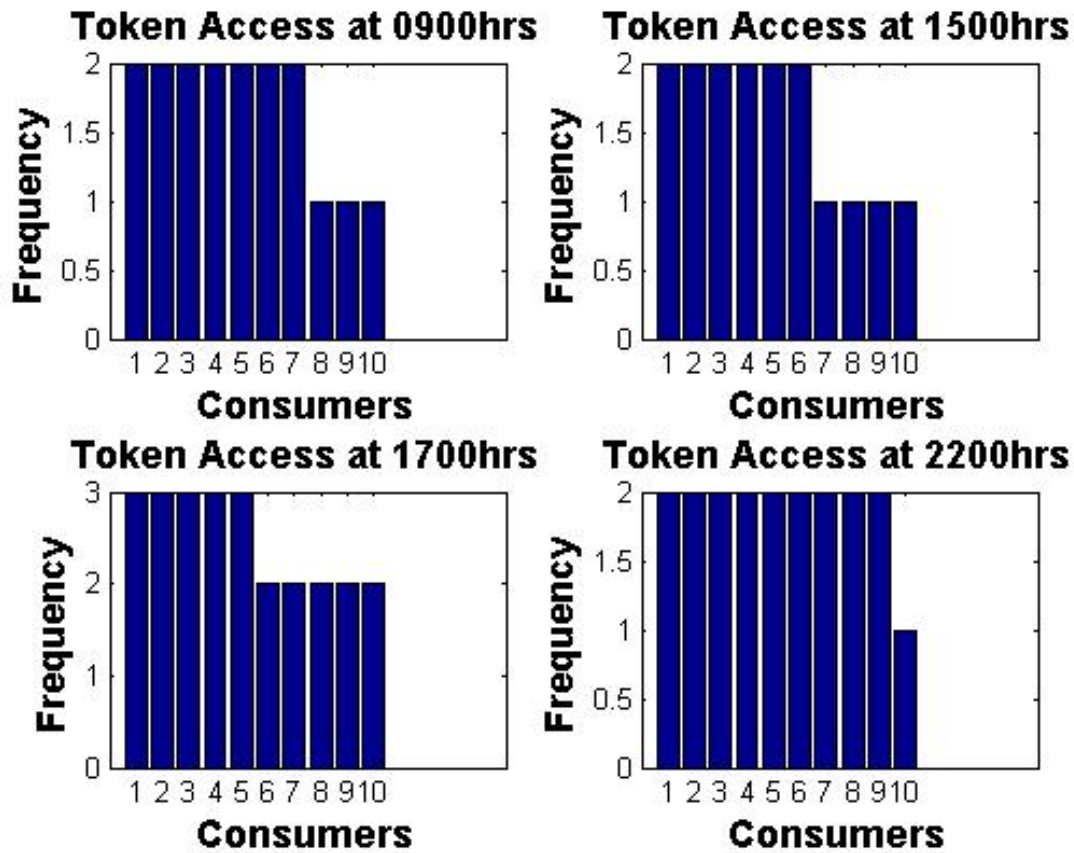

Figure 38: Access to shared capacity.

While DSM works by shifting demand from peak hours to off-peak, Fig. 42 indicates that loads shifted to 2000 and 2300 hours. Based on applied ToU pricing, 2000 hours is in peak hours and 2300 hours is in off-peak hours. Likewise, Fig. 43 indicates loads shifted to 1800, 2100 and 2300 hours. 1800 and 2100 hours are peak hours and 2300 hours is off-peak hour. Both figures, this occurs when electricity is drawn from both grid and GES.

There are times when only a fraction of requested load can be run using energy stored in batteries, so the rest of the energy has to be drawn from the grid. But since electricity drawn from grid is subject to capacity constraints, if maximum capacity is reached, then the remaining fraction that has to be drawn from the grid is shifted to next hour so as to reduce inconveniences for the consumer with GES. This enables utilities to spread shifted loads over several hours and thereby mitigate reverse peaks and avoid dropping loads when total shifted loads exceed maximum capacity constraints.

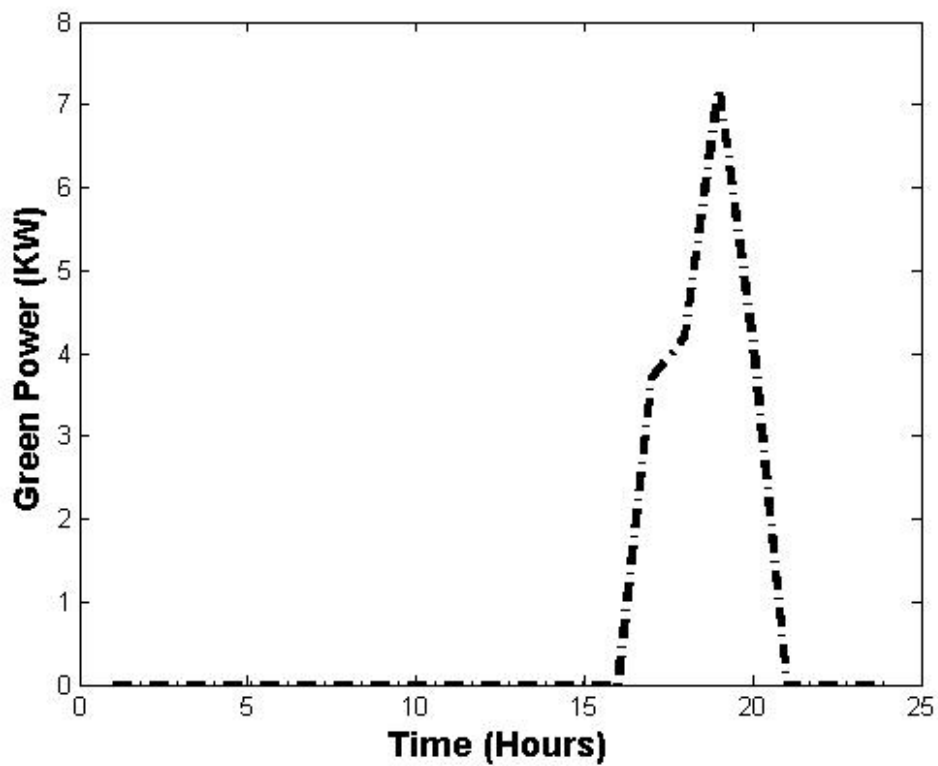

Figure 39: Green power consumed.

Figure 42 illustrates how utilities can spread shifted. In the shown figure, load shifted to 1800 hours (12.1KWh) is 23.4% of the total shifted demand. Without GES, this load would be dropped if there was a capacity constraint or cause an even higher reverse peak if there was no capacity constraint because all of it would be shifted to 2300 hours which is off-peak hour as in Fig. 44.

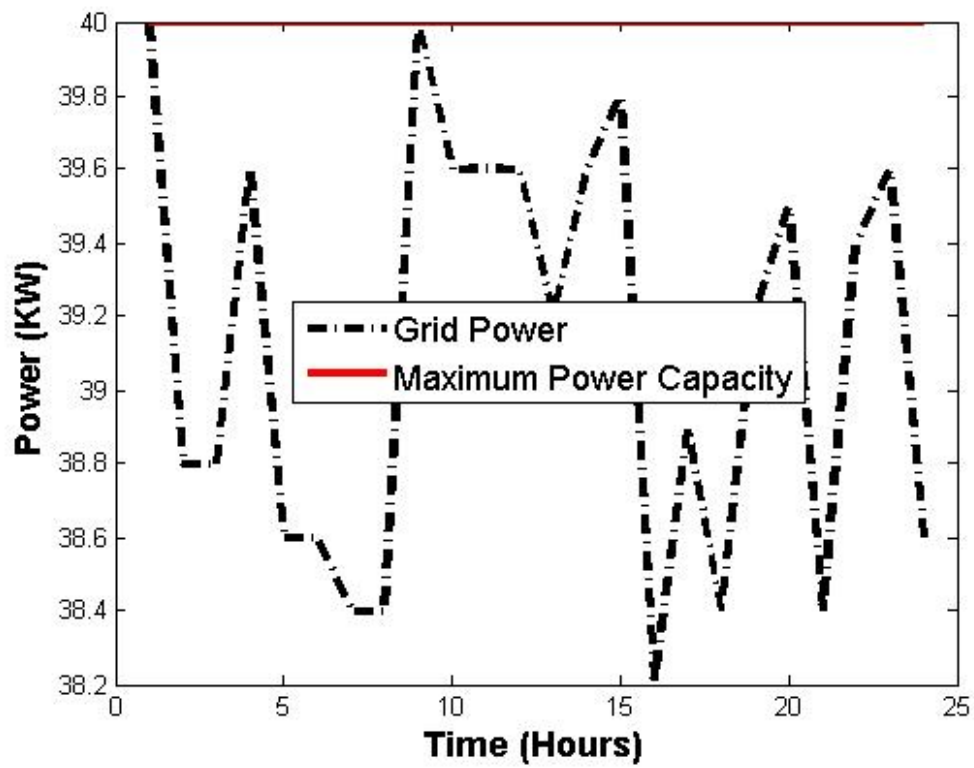

Figure 40: Power consumed from the grid.

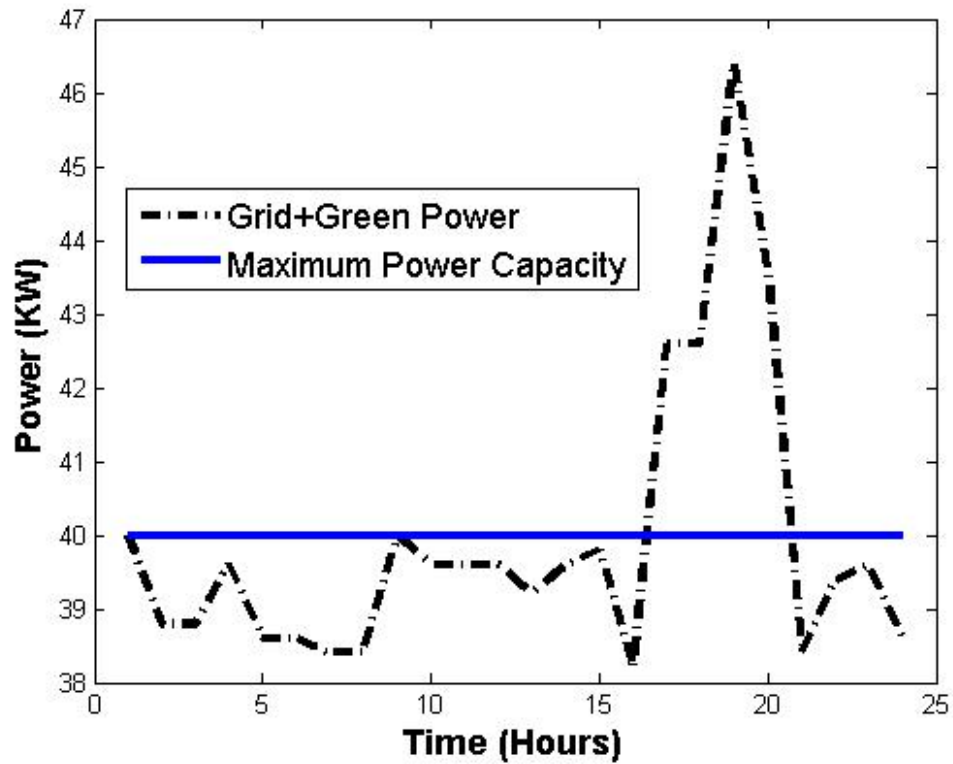

Figure 41: Total consumed power(Grid+Green).

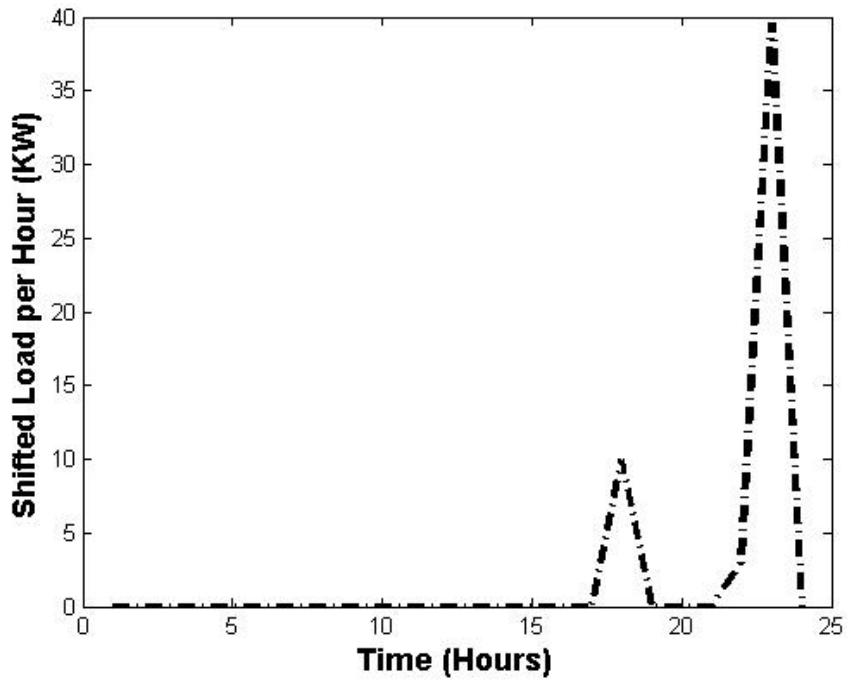

Figure 42: Two reverse peaks for community with GES and storage.

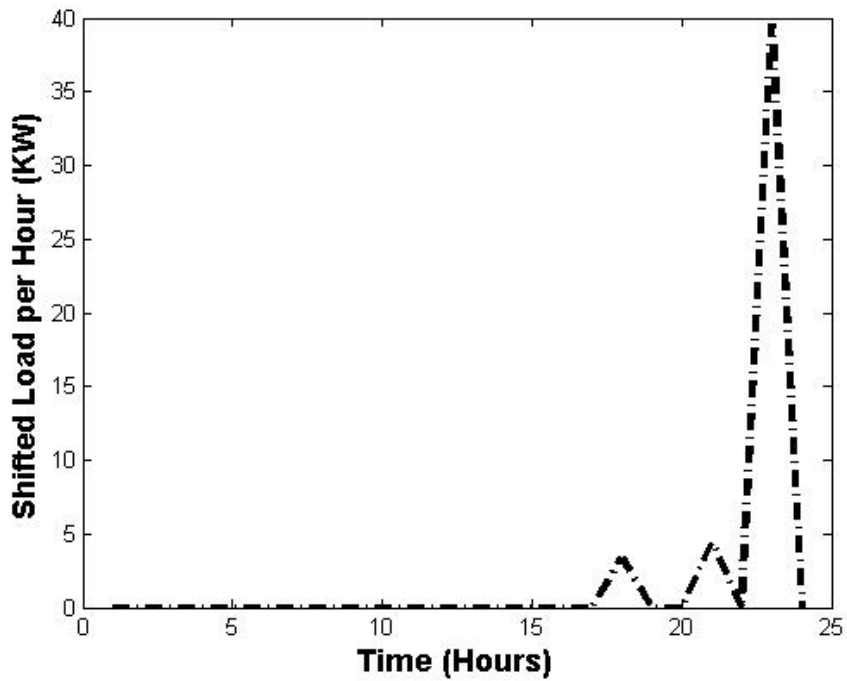

Figure 43: Three reverse peaks for community with GES and storage.

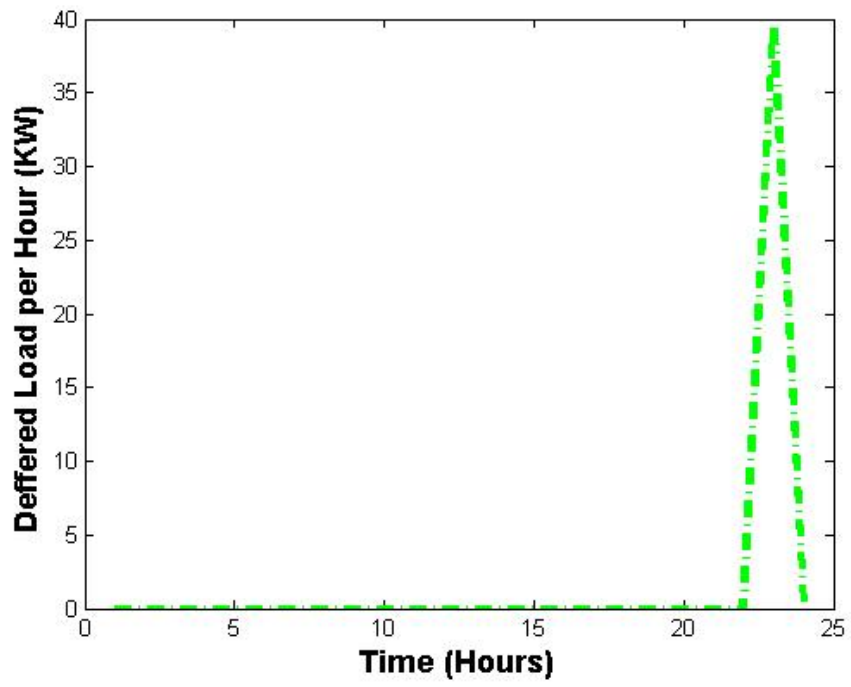

Figure 44: Token-based scheduling algorithm without GES-all deferred loads shifted to 2300 hours.

6.6 Conclusion

Community based DSM programs provides better opportunity to exploit consumption diversity and consequently reduce peak demand of electricity. Shifting load from peak to off-peak period can be a challenge to some consumers, hence exploiting rapidly growing PV solar technology and integrating it with the grid leads to more flexible DSM programs. The green-aware and access guaranteed scheduling algorithm proposed in this work has the potential to reduce PAR and energy cost by up 27.7% and 14.0% respectively, without relying entirely on demand shifting. Moreover, the algorithm can be used to mitigate reverse peaks by up to 23.4%. Grid reliability can be improved by encouraging and integrating distributed generation and storage of GES on the consumer side. This work can be extended to account for cases where consumers are able to sell extra energy to the grid and among themselves. Also, a shared GES in the community such as Wind farm and its storage can be studied. The next chapter summarizes what has been done in Chapter Three to Chapter Six, identifies lessons that can be learned, recommends measures to be taken to benefits from results of entire work and points out directions for future works.

CHAPTER SEVEN

General Discussion, Conclusion, and Recommendations

7.1 General Discussion

From Chapter Three to Chapter Six, results from four articles forming part of this dissertation have been presented, discussed, interpreted and compared with relevant literature. In this chapter, a summary of the main findings of this work is presented and conclusions aiming at responding to formulated objectives are drawn. Four key contributions emanating from this work are: establishment of current extent of DSM programs; reduction of demand-supply variability in deregulated electricity market; assurance of guaranteed and equitable access to shared power capacity by consumers; and reduction of reverse peaks and dropped loads through coordinated charging and discharging of GES. In addition, recommendations stemming from this work and directions for future works are presented.

Considerable review works regarding DSM programs are narrative and therefore provide an analysis that is qualitative in nature. We have complemented existing review works by providing a systematic quantitative analysis of the extent of DSM programs in the world. We have specifically established authorship and chronology of DSM programs, geographical spread of residential DSM programs, issues being studied, methods employed in DSM programs and patterns found in studied DSM programs. Results show growing interest by diverse disciplines in DSM programs, even though, it is largely in the developed world. Cost savings for consumers is the most common issue that drives many DSM initiatives, while utilities are supposed to benefit from reduced PAR. Moreover, results indicate most studied programs assume no constraint on power drawn from the grid. Developing countries appear to be solely focusing on investment in new generation so as to meet existing and future demand. Since demand is growing at a rate that outstrips current investment in new generation, it is unsustainable and unreliable to solely focus on new generation capacity. A holistic approach that takes into account energy efficient building standards, distributed generation, DSM and financial and

resource constraints of stakeholders is necessary so as to ensure sustainable and reliable access to grid power.

A recent trend of electric grids is towards deregulation so as to improve efficiency and encourage investment through competition. Among other things, deregulation of grids means multiple utilities operating in the market, thereby causing variability of both demand and supply. To improve grid reliability, a balance between demand and supply has to be established. In this work, an algorithm that models an electricity market as a potluck problem with non-rational learning has been developed. In the market, utilities act both as producers and consumers of electricity. Using past consumption data, the algorithm enables each utility to establish equilibrium demand and supply for each hour in a day. Simulation results indicate equilibrium demand has MAPE values of 5% to 33% compared with actual demand, more importantly equilibrium demand curve is flatter than the actual one (e.g., PAR=1.06 vs PAR=1.26). Our approach indicates improvement compared to similar work which exhibits MAPE values of 10.4% and 57.9%. Unlike works that seek to accurately predict demand based on past consumption patterns, this work establishes equilibrium demand while taking into account past consumption. With most grids' demand growing at a rate that outstrips investment in new generation, it is not sustainable to approach demand-supply balance using supply-follow demand strategy, rather it should be demand-follow supply. With demand-follow supply approach, equilibrium demand established by the proposed algorithm can be used to constrain power drawn from the grid. The difference between actual and equilibrium demand can be compensated by DSM programs. Developing countries can be able increase access to electricity because of effective utilization of existing generation capacities.

With constrained power drawn from the grid, there is a possibility of some consumers may be starved. A scheduling algorithm that ensures guaranteed and equitable access to shared power capacity has been developed. Inspired by token-based algorithms used in communication networks, the algorithm schedules appliances using a token. Simulation results indicate better access variances (0.1 to 0.3) than that of similar capacity sharing algorithm (0.9 to 2.3), for cost savings of up to 16%. Guaranteed and equitable access to shared power capacity is importance for consumer confidence and acceptance of DSM programs. It provides an opportunity for consumers to embrace DSM initiatives.

Effectiveness of DSM programs with constrained grid power capacity depends on pricing. If prices are not correctly set, there is a possibility of undesirable impacts of scheduling such as reverse peaks and too many dropped loads to occur. The GES and storage owned by consumers can be coordinated so as to alleviate adverse impacts of scheduling. We have proposed a green-aware scheduling algorithm that coordinates PV solar charging and discharging of battery storage so as to mitigate demand scheduling impacts. Results indicate reverse peaks and dropped loads can be reduced by 23.4%. In developing countries where self-generation is high, initiatives to improve grid efficiency and reliability should consider coordinating GES on consumer side.

7.2 Conclusion

Major findings that have emanated from papers/manuscripts forming part of this dissertation are as follows:

- (i) To sustainably maintain electricity demand-supply balance in developing countries, DSM programs should be employed, in addition to investment in new generation.
- (ii) Managing interaction both among utilities and between utilities and consumers is crucial for grid reliability.
- (iii) Equitable and guaranteed access to shared power capacity is likely to enhance acceptance of DSM programs by consumers.
- (iv) Investment in green energy can help reduce potential scheduling discomfort associated with DSM Programs.

7.3 Recommendations

Managing demand on the consumer side is an important element of envisaged modern electricity grids. From results and discussions emanating from this work, the following recommendations are made to various stakeholders of the electricity sector:

- (i) Governments should restructure electricity markets so as to make them competitive and responsive to price signals.
- (ii) The Ministry of Energy and Non-Government Organizations (NGOs) in the energy sector should create awareness to stakeholders on the importance of sustainable consumption of electricity.
- (iii) Utilities and NGOs in the energy sector should create awareness to consumers regarding variations of both running cost and electricity consumption during peak and off-peak hours.
- (iv) The Ministry of Finance should provide tax reduction or exemption for consumers purchasing smart appliances.
- (v) The Ministry of Energy, Higher Learning Institutions, Electricity Utility Company, Communications providers and manufacturers of smart equipment should invest in large-scale acquisition, testing and deployment of smart meters. Benefits of the proposed DSM programs are based on analysis of consumption simulations. Increase in deployment of smart meters presents an opportunity to verify experimentally the proposed programs. Experiment verification will provide more insights into constraints that may have been overlooked by simulations. Utilities in developing countries need to deploy smart meters, even if it means they are going to be used for research, development and testing purposes only.
- (vi) The Ministry of Energy should formulate a DSM framework to guide operations of consumers, regulator, utilities and wholesalers of electricity.
- (vii) The government should revise building regulations so as to encourage use of energy efficiency standards and On-site generation of electricity. Policies can be formulated to set specific percentage of electricity consumption to be generated on-site using various GES technologies. Incentives in terms of subsidy or reduced taxes can be used to attract investments in distributed generation using GES.

7.4 Future Work

Based on what has been done in this study, research on DSM programs can be extended so as to provide a broader understanding of dynamics associated with demand management of electricity. Directions for future work are as follows:

- (i) This work has evaluated the extent of English literature on residential DSM programs. Results indicate geographical diversity of research, although studies have predominantly been done in Europe and North America. It is possible that these results are biased due to the fact that only papers in English journals were considered. A multi-lingual systematic review in major languages such as Arabic, Chinese, Portuguese, French, etc; might provide a broader perspective on DSM programs.
- (ii) In this work, we have established financial savings that consumers can make by adhering to proposed DSM program. However, no financial considerations were made for utilities. In deregulated electricity market environment, utilities are likely to be more motivated by increasing their revenues than ensuring grid stability and reliability. Establishing financial implication of DSM programs to utilities for different types of energy sources will add value to this work.
- (iii) This work has proposed residential DSM programs. However, in most countries, very few places are residential per se. In developing countries there is rarely a clear demarcation of residential, industrial or commercial place or building. It therefore needs a holistic approach to designing DSM programs such that it is flexible enough to account for residential, industrial or commercial consumers.
- (iv) Proposed DSM programs have not considered HVAC appliances. Further flexibility and cost savings for consumers can be attained by taking into considerations thermal inertia of HVAC appliances. Residences can be equipped with sensors that monitor outdoor and indoor temperature so that an appropriate comfort level can be automatically adjusted on HVAC appliances depending on thermal comfort levels set by the consumer. Since HVAC appliances have thermal inertia, it means they can be switched off momentarily and therefore save power without affecting thermal comfort of the consumers.

- (v) Although fixed appliances such as lights, televisions, laptops, etc, have not been considered for scheduling; they can still be used to manage demand. DSM programs that consider residences with motion or light sensors to establish presence of people, can be used to decide whether to switch off/on the fixed appliances.
- (vi) Proposed DSM programs are based on two-level ToU pricing scheme. It is simple and hence easily understood by consumers. Other pricing schemes such as RLP where electricity prices may vary every hour. The RLP presents more flexibility in cost savings. It would be interesting to see how proposed programs fare with RLP and CPP pricing schemes, especially in addressing potential reverse peaks.
- (vii) In this work, solar energy source has been used to provide more flexibility to proposed DSM program. Since wind energy source is relatively more expensive than solar, a Micro-grid with wind energy source shared by community with centralized storage can be considered for demand management so as reduce grid dependence. Moreover, DSM programs can be designed such that communities may be able to sell excess power to the grid using feed-in tariffs so as to encourage investment in GES, reduce transmission losses and enable consumers to make money.

REFERENCES

- Aalami, H. A., Moghaddam, M. P. and Yousefi, G. R. (2009). Demand response modeling considering interruptible/curtailable loads and capacity market programs. *Applied Energy*. **87**(1): 243–250.
- OpenEI (2017). Residential load data. http://en.openei.org/datasets/files/961/pub/RESIDENTIAL_LOAD_DATA_E_PLUS_OUTPUT/BASE/. Accessed on August 03, 2017.
- Aalami, H. A., Moghaddam, M. P. and Yousefi, G. R. (2010). Modeling and prioritizing demand response programs in power markets. *Electric Power Systems Research*. **80**(4): 426–435.
- Abhyankar, A. and Khaparde, S. (2013). Introduction to deregulation in power industry. Indian Institute of Technology, Mumbai. [http://nptel.ac.in/courses/Webcourse-contents/IITBombay/Power System Operation and Control/Module 7/L01-Introduction to Deregulation-1.pdf](http://nptel.ac.in/courses/Webcourse-contents/IITBombay/Power_System_Operation_and_Control/Module_7/L01-Introduction_to_Deregulation-1.pdf). Accessed on July 29, 2017.
- Adika, C. O. and Wang, L. (2013). Autonomous appliance scheduling for household energy management. *IEEE Transactions on Smart Grid*. **5**(2): 673–682.
- Adika, C. O. and Wang, L. (2014). Smart charging and appliance scheduling approaches to demand side management. *International Journal of Electrical Power & Energy Systems*. **57**: 232–240.
- Afram, A. and Janabi-Sharifi, F. (2015). Gray-box modeling and validation of residential HVAC system for control system design. *Applied Energy*. **137**: 134–150.
- Ahlborg, H. and Hammar, L. (2014). Drivers and barriers to rural electrification in Tanzania and Mozambique—Grid-extension, off-grid, and renewable energy technologies. *Renewable Energy*. **61**: 117–124.
- Aker, J. C. and Mbiti, I. M. (2010). Mobile phones and economic development in Africa. *The Journal of Economic Perspectives*. **24**(3): 207–232.

- Alahmad, M. A., Wheeler, P. G., Schwer, A., Eiden, J. and Brumbaugh, A. (2012). A comparative study of three feedback devices for residential real-time energy monitoring. *IEEE Transactions on Industrial Electronics*. **59**(4): 2002–2013.
- Ali, M., Jokisalo, J., Siren, K. and Lehtonen, M. (2014). Combining the demand response of direct electric space heating and partial thermal storage using LP optimization. *Electric Power Systems Research*. **106**: 160–167.
- Alimohammadisagvand, B., Alam, S., Ali, M., Degefa, M., Jokisalo, J. and Sirén, K. (2015). Influence of energy demand response actions on thermal comfort and energy cost in electrically heated residential houses. *Indoor and Built Environment*. pp 1–19.
- Alizadeh, M., Scaglione, A. and Thomas, R. J. (2012). From packet to power switching: Digital direct load scheduling. *IEEE Journal on Selected Areas in Communications*. **30**(6): 1027–1036.
- Álvarez-Bel, C., Escrivá-Escrivá, G. and Alcázar-Ortega, M. (2013). Renewable generation and demand response integration in micro-grids: development of a new energy management and control system. *Energy Efficiency*. **6**(4): 695–706.
- Anees, A. S. (2012). Grid integration of renewable energy sources: Challenges, issues and possible solutions. In: *Power Electronics (IICPE). 2012 IEEE 5th India International Conference on*. (Edited by IEEE). 6-8 December 2012, Delhi India, pp 1–6.
- Arango, S., Dyer, I. and Larsen, E. R. (2006). Lessons from deregulation: Understanding electricity markets in South America. *Utilities Policy*. **14**(3): 196–207.
- Arif, A., Javed, F. and Arshad, N. (2014). Integrating renewables economic dispatch with demand side management in micro-grids: a genetic algorithm-based approach. *Energy Efficiency*. **7**(2): 271–284.
- Arteconi, A., Hewitt, N. J. and Polonara, F. (2013). Domestic demand-side management (DSM): Role of heat pumps and thermal energy storage (TES) systems. *Applied Thermal Engineering*. **51**(1): 155–165.

- Atzeni, I., Ordóñez, L. G., Scutari, G., Palomar, D. P. and Fonollosa, J. R. (2013a). Demand-side management via distributed energy generation and storage optimization. *IEEE Transactions on Smart Grid*. **4**(2): 866–876.
- Atzeni, I., Ordóñez, L. G., Scutari, G., Palomar, D. P. and Fonollosa, J. R. (2013b). Noncooperative and cooperative optimization of distributed energy generation and storage in the demand-side of the smart grid. *IEEE Transactions on Signal Processing*. **61**(10): 2454–2472.
- Bae, H., Yoon, J., Lee, Y., Lee, J., Kim, T., Yu, J. and Cho, S. (2014). User-friendly demand side management for smart grid networks. In: *Information Networking (ICOIN). 2014 International Conference on*. (Edited by IEEE). 10-12 February 2014, Phuket Thailand, pp 481–485.
- Bakr, S. and Cranefield, S. (2013). Optimizing Shiftable Appliance Schedules across Residential Neighbourhoods for Lower Energy Costs and Fair Billing. In: *AIH+ CARE@ AUS-AI*. pp 45–52.
- Banu, I.-V. and Istrate, M. (2012). Modeling and simulation of photovoltaic arrays. *Buletinul AGIR*. **3**: 161–166.
- Barbato, A. and Capone, A. (2014). Optimization models and methods for demand-side management of residential users: A survey. *Energies*. **7**(9): 5787–5824.
- Bayar, Y., Özel, H. A. and Others (2014). Electricity consumption and economic growth in emerging economies. *Journal of Knowledge Management, Economics and Information Technology*. **4**(2): 411–419.
- Bell, A. M. and Sethares, W. A. (2001). Avoiding global congestion using decentralized adaptive agents. *Signal Processing, IEEE Transactions on* **49**(11): 2873–2879.
- Bell, A., Sethares, W. and Bucklew, J. (2003). Coordination failure as a source of congestion in information networks. *Signal Processing, IEEE Transactions on*. **51**(3): 875–885.
- Belson, K. (2008). Lower Rates, But Not Until 10:00PM. <http://www.nytimes.com/2008/07/21/nyregion/21peak.html>. Accessed on December 12, 2016.

- Bjørndal, M., Gribkovskaia, V. and Jörnsten, K. (2010). Market power in a power market with transmission constraints. *In: Energy Market (EEM). 2010 7th International Conference on the European.* (Edited by IEEE). 23-35 June 2010, Madrid Spain, pp 1–6.
- Boaro, M., Fuselli, D., De Angelis, F., Liu, D., Wei, Q. and Piazza, F. (2013). Adaptive dynamic programming algorithm for renewable energy scheduling and battery management. *Cognitive Computation.* **5**(2): 264–277.
- Bose, S., Wu, C., Xu, Y., Wierman, A. and Mohsenian-Rad, H. (2014). A unifying market power measure for deregulated transmission-constrained electricity markets. *Power Systems, IEEE Transactions on.* **30**(5): 2338–2348.
- Bozchalui, M. C., Hashmi, S. A., Hassen, H., Cañizares, C. A. and Bhattacharya, K. (2012). Optimal operation of residential energy hubs in smart grids. *IEEE Transactions on Smart Grid.* **3**(4): 1755–1766.
- Bozkurt, I., Foster, V. and Steinbuks, J. (2010). Energy resources and their effects on environment. *WSEAS Transactions on Environment and Development.* **6**(5): 327–334.
- Braimah, I. and Amponsah, O. (2012). Causes and effects of frequent and unannounced electricity blackouts on the operations of micro and small scale industries in Kumasi. *Journal of Sustainable Development.* **5**(2): 17.
- Broeer, T., Fuller, J., Tuffner, F., Chassin, D. and Djilali, N. (2014). Modeling framework and validation of a smart grid and demand response system for wind power integration. *Applied Energy.* **113**: 199–207.
- Bu, H. and Nygard, K. (2014). Adaptive scheduling of smart home appliances using fuzzy goal programming. *In: The Sixth International Conference on Adaptive and Self-Adaptive Systems and Applications, ADAPTIVE.* (Edited by Citeseer). 25-29 March 2014, Venice Italy, pp 129–135.
- Bualan, R., Cooper, J., Chao, K.-M., Stan, S. and Donca, R. (2011). Parameter identification and model based predictive control of temperature inside a house. *Energy and Buildings.* **43**(2): 748–758.

- Bye, T. and Hope, E. (2005). Deregulation of electricity markets: the Norwegian experience. *Economic and Political Weekly*. pp 5269–5278.
- Caamano-Martin, E., Matallanas, E., Masa-Bote, D., Gutierrez, A., Monasterio-Huelin, F., Jimenez-Leube, J. and Castillo-Cagigal, M. (2011). PV self-consumption optimization with storage and active DSM for the residential sector. *Solar Energy*. **85**(9): 2338–2348.
- Cardenas, A. A., Roosta, T. and Sastry, S. (2009). Rethinking security properties, threat models, and the design space in sensor networks: A case study in SCADA systems. *Ad Hoc Networks*. **7**(8): 1434–1447.
- Castillo-Cagigal, M., Gutierrez, A., Monasterio-Huelin, F., Caamano-Martin, E., Masa, D. and Jimenez-Leube, J. (2011). A semi-distributed electric demand-side management system with PV generation for self-consumption enhancement. *Energy Conversion and Management*. **52**(7): 2659–2666.
- Cecati, C., Citro, C. and Siano, P. (2011). Combined operations of renewable energy systems and responsive demand in a smart grid. *IEEE Transactions on Sustainable Energy*. **2**(4): 468–476.
- Chaabene, M., Ammar, M. B. and Elhajjaji, A. (2007). Fuzzy approach for optimal energy-management of a domestic photovoltaic panel. *Applied Energy*. **84**(10): 992–1001.
- Chu, C.-M. and Jong, T.-L. (2008). A novel direct air-conditioning load control method. *IEEE Transactions on Power Systems*. **23**(3): 1356–1363.
- Cipriani, A. and Geddes, J. (2003). Comparison of systematic and narrative reviews: the example of the atypical antipsychotics. *Epidemiology and Psychiatric Sciences*. **12**(3): 146–153.
- Costanzo, G. T., Zhu, G., Anjos, M. F. and Savard, G. (2012). A system architecture for autonomous demand side load management in smart buildings. *IEEE Transactions on Smart Grid*. **3**(4): 2157–2165.
- Dai, Y. and Gao, Y. (2014). Real-Time Pricing Decision Making for Retailer-Wholesaler in Smart Grid Based on Game Theory. *Abstract and Applied Analysis*. **2014**: 1–7.

- Dallinger, D. and Wietschel, M. (2012). Grid integration of intermittent renewable energy sources using price-responsive plug-in electric vehicles. *Renewable and Sustainable Energy Reviews*. **16**(5): 3370–3382.
- Darabi, Z. and Ferdowsi, M. (2011). Aggregated impact of plug-in hybrid electric vehicles on electricity demand profile. *IEEE Transactions on Sustainable Energy*. **2**(4): 501–508.
- Davito, B., Tai, H. and Uhlaner, R. (2010). The smart grid and the promise of demand-side management. McKinsey and Company. <http://pvwatts.nrel.gov/pvwatts.php>. Accessed on February 19, 2017.
- De Angelis, F., Boaro, M., Fuselli, D., Squartini, S., Piazza, F. and Wei, Q. (2013). Optimal home energy management under dynamic electrical and thermal constraints. *IEEE Transactions on Industrial Informatics*. **9**(3): 1518–1527.
- Deilami, S., Masoum, A. S., Moses, P. S. and Masoum, M. A. S. (2011). Real-time coordination of plug-in electric vehicle charging in smart grids to minimize power losses and improve voltage profile. *IEEE Transactions on Smart Grid*. **2**(3): 456–467.
- Derin, O. and Ferrante, A. (2010). Scheduling energy consumption with local renewable micro-generation and dynamic electricity prices. In: *First Workshop on Green and Smart Embedded System Technology: Infrastructures, Methods, and Tools*. 12 April 2010, Stockholm Sweden, pp 1–6.
- Di Giorgio, A. and Pimpinella, L. (2012). An event driven smart home controller enabling consumer economic saving and automated demand side management. *Applied Energy*. **96**: 92–103.
- Doorman, G. (2003). Capacity subscription and security of supply in deregulated electricity markets, Presentation held at Research Symposium European Electricity Market on 26 September 2003 in The Hague. In: *Research Symposium European Electricity Market*. 26 September 2003, The Hague Netherlands, pp 1–9.

- EEI-AEIC-UTC (2011). Smart Meters and Smart Meter Systems: A Metering Industry Perspective. Association of Edison Illuminating Companies. <https://aeic.org/wp-content/uploads/2013/07/smartmetersfinal032511.pdf>. Accessed on May 5, 2016.
- Effah, E. and Owusu, K. B. (2014). Evolution and Efficiencies of Energy Metering Technologies in Ghana. *Global Journal of Research In Engineering*. **14**(6): 35–42.
- Eissa, M. M. (2011). Demand side management program evaluation based on industrial and commercial field data. *Energy Policy*. **39**(10): 5961–5969.
- El-Amin, I. M., Al-Ali, A. R. and Suhail, M. A. (1999). Direct load control using a programmable logic controller. *Electric Power Systems Research*. **52**(3): 211–216.
- El-Hawary, M. E. (2014). The smart grid state-of-the-art and future trends. *Electric Power Components and Systems*. **42**(3-4): 239–250.
- Ela, E., Milligan, M. and Kirby, B. (2011). Operating reserves and variable generation. *Contract*. **303**: 275–3000.
- Energinet (2016). Download of Market Data-Production and Consumption. Energinet. <http://energinet.dk/EN/EI/Engrosmarked/Udtraek-af-markedsdata/Sider/default.aspx>. Accessed on April, 2016.
- Enumula, P. K. and Rao, S. (2010). The potluck problem. *Economics Letters*. **107**(1): 10–12.
- Erol-Kantarci, M. and Mouftah, H. T. (2011). Wireless sensor networks for cost-efficient residential energy management in the smart grid. *IEEE Transactions on Smart Grid*. **2**(2): 314–325.
- Escrivá-Escrivá, G., Segura-Heras, I. and Alcázar-Ortega, M. (2010). Application of an energy management and control system to assess the potential of different control strategies in HVAC systems. *Energy and Buildings*. **42**(11): 2258–2267.
- Fadlullah, Z. M., Quan, D. M., Kato, N. and Stojmenovic, I. (2014). GTES: An optimized game-theoretic demand-side management scheme for smart grid. *Systems Journal, IEEE*. **8**(2): 588–597.

- Fan, Z., Kulkarni, P., Gormus, S., Efthymiou, C., Kalogridis, G., Sooriyabandara, M., Zhu, Z., Lambbotharan, S. and Chin, W. H. (2013). Smart grid communications: Overview of research challenges, solutions, and standardization activities. *IEEE Communications Surveys & Tutorials*. **15**(1): 21–38.
- Fang, X., Misra, S., Xue, G. and Yang, D. (2012). Smart grid-The new and improved power grid: A survey. *IEEE Communications Surveys & tutorials*. **14**(4): 944–980.
- Farhangi, H. (2010). The path of the smart grid. *IEEE Power and Energy Magazine*. **8**(1).
- Faruqui, A. and Eakin, K. (2012). Pricing in competitive electricity markets. Vol. 36. Springer Science & Business Media.
- Faxas-Guzmán, J., Garcia-Valverde, R., Serrano-Luján, L. and Urbina, A. (2014). Priority load control algorithm for optimal energy management in stand-alone photovoltaic systems. *Renewable Energy*. **68**: 156–162.
- Fernandes, F., Morais, H., Vale, Z. and Ramos, C. (2014). Dynamic load management in a smart home to participate in demand response events. *Energy and Buildings*. **82**: 592–606.
- Ferruzzi, G., Graditi, G., Rossi, F. and Russo, A. (2015). Optimal operation of a residential microgrid: The role of demand side management. *Intelligent Industrial Systems*. **1**(1): 61–82.
- Finn, P., O’Connell, M. and Fitzpatrick, C. (2013). Demand side management of a domestic dishwasher: Wind energy gains, financial savings and peak-time load reduction. *Applied Energy*. **101**: 678–685.
- Fischer, D., Stephen, B., Flunk, A., Kreifels, N., Lindberg, K., Wille-Hausmann, B. and Owens, E. (2016). Modelling the effects of variable tariffs on domestic electric load profiles by use of occupant behavior submodels. *IEEE Transactions on Smart Grid*. **8**(6): 678–685.
- Fuller, J. C. and Parker, G. B. (2012). Modeling of GE appliances: cost benefit study of smart appliances in wholesale energy, frequency regulation, and spinning reserve markets, Technical report, Pacific Northwest National Laboratory (PNNL). Richland, WA (US).

- Gallo, D., Landi, C., Luiso, M., Bucci, G. and Fiorucci, E. (2013). Low cost smart power metering. *In: Instrumentation and Measurement Technology Conference (I2MTC). 2013 IEEE International.* (Edited by IEEE). 6-9 May 2013, Minneapolis USA, pp 763–767.
- Galus, M. D. and Andersson, G. (2008). Demand management of grid connected plug-in hybrid electric vehicles (PHEV). *In: Energy 2030 Conference, 2008. ENERGY 2008. IEEE.* (Edited by IEEE). 17-18 November 2008, Atlanta USA, pp 1–8.
- Gatsis, N. and Giannakis, G. B. (2012). Residential load control: Distributed scheduling and convergence with lost AMI messages. *IEEE Transactions on Smart Grid.* **3**(2): 770–786.
- Gelazanskas, L. and Gamage, K. (2014). Demand side management in smart grid: a review and proposals for future direction. *Sustainable Cities and Society.* **11**: 22–30.
- Ghansah, I. (2009). Smart grid cyber security potential threats, vulnerabilities and risks. California Energy Commission. www.energy.ca.gov/2012publications/CEC-500-2012-047/CEC-500-2012-047.pdf. Accessed on August 19, 2017.
- Giraud, F. and Salameh, Z. M. (2001). Steady-state performance of a grid-connected rooftop hybrid wind-photovoltaic power system with battery storage. *IEEE Transactions on Energy Conversion.* **16**(1): 1–7.
- Gottwalt, S., Ketter, W., Block, C., Collins, J. and Weinhardt, C. (2011). Demand side managementA simulation of household behavior under variable prices. *Energy Policy.* **39**(12): 8163–8174.
- Goudarzi, H., Hatami, S. and Pedram, M. (2011). Demand-side load scheduling incentivized by dynamic energy prices. *In: Smart Grid Communications (SmartGridComm). 2011 IEEE International Conference on.* (Edited by IEEE). 17-20 October 2011, Brussels Belgium, pp 351–356.
- Grant, M. J. and Booth, A. (2009). A typology of reviews: an analysis of 14 review types and associated methodologies. *Health Information & Libraries Journal.* **26**(2): 91–108.

- Griffin, J. M. and Puller, S. L. (2009). *Electricity Deregulation: Choices and Challenges*, Vol. 4, University of Chicago Press.
- Guitart, D., Pickering, C. and Byrne, J. (2012). Past results and future directions in urban community gardens research. *Urban Forestry & Urban Greening*. **11**(4): 364–373.
- Gungor, V. C., Sahin, D., Kocak, T., Ergut, S., Buccella, C., Cecati, C. and Hancke, G. P. (2011). Smart grid technologies: communication technologies and standards. *IEEE Transactions on Industrial Informatics*. **7**(4): 529–539.
- Gutiérrez, A., Jiménez-Leube, J. and Magdalena, L. (2009). A distributed sensor network for the control of a bioclimatic house in Spain. *Sensors*. **9**(10): 8197–8214.
- Gyamfi, S. and Krumdieck, S. (2011). Price, environment and security: Exploring multi-modal motivation in voluntary residential peak demand response. *Energy Policy*. **39**(5): 2993–3004.
- Hakimi, S. M. and Moghaddas-Tafreshi, S. M. (2014). Optimal planning of a smart microgrid including demand response and intermittent renewable energy resources. *IEEE Transactions on Smart Grid*. **5**(6): 2889–2900.
- Hamel, R. E. (2007). The dominance of English in the international scientific periodical literature and the future of language use in science. *Aila Review*. **20**(1): 53–71.
- Haney, A. B., Jamasb, T., Platchkov, L. M. and Pollitt, M. G. (2010). Demand-side management strategies and the residential sector: lessons from international experience. <https://doi.org/10.17863/CAM.5572>. Accessed on August 25, 2016.
- Hansen, U. E., Pedersen, M. B. and Nygaard, I. (2014). Review of Solar PV market development in East Africa. UNEP. <http://pubdocs.worldbank.org/en/600611475093991341/Solar-PV-market-East-Africa-UNEP-2014.pdf>. Accessed on June 30, 2017.
- Holtschneider, T. and Erlich, I. (2012). Modeling demand response of consumers to incentives using fuzzy systems. In: *Power and Energy Society General Meeting, 2012 IEEE*. (Edited by IEEE). 22-26 July 2012, California USA, pp 1–8.

- Hu, Q. and Li, F. (2013). Hardware design of smart home energy management system with dynamic price response. *IEEE Transactions on Smart Grid*. **4**(4): 1878–1887.
- Huang, L., Walrand, J. and Ramchandran, K. (2012). Optimal demand response with energy storage management. In: *Smart Grid Communications (SmartGridComm). 2012 IEEE Third International Conference on*. (Edited by IEEE). 5-8 November 2012, Tainan City Taiwan, pp 61–66.
- Huang, T. and Liu, D. (2013). A self-learning scheme for residential energy system control and management. *Neural Computing and Applications*. **22**(2): 259–269.
- Hubert, T. and Grijalva, S. (2012). Modeling for residential electricity optimization in dynamic pricing environments. *IEEE Transactions on Smart Grid*. **3**(4): 2224–2231.
- Ilic, M., Galiana, F. and Fink, L. (2013). *Power Systems Restructuring: Engineering and Economics*. Springer Science & Business Media.
- Jalali, M. M. and Kazemi, A. (2015). Demand side management in a smart grid with multiple electricity suppliers. *Energy*. **81**: 766–776.
- Jamal, M. (2015). Taking the Power Back. *Finance & Development*. **54**(4): 24–25.
- Javaid, N., Khan, I., Ullah, M. N., Mahmood, A. and Farooq, M. U. (2013). A survey of home energy management systems in future smart grid communications. In: *Broadband and Wireless Computing, Communication and Applications (BWCCA). 2013 Eighth International Conference on*. (Edited by IEEE). 23-30 October 2013, Compiègne France, pp 459–464.
- Joskow, P. L. (2008). Lessons learned from electricity market liberalization. *The Energy Journal*. **29**(2): 9–42.
- Joung, M. (2008). Game-theoretic equilibrium analysis applications to deregulated electricity markets. ProQuest. <http://hdl.handle.net/2152/17875>. Accessed on December 11, 2015.
- Kamaludin, M. (2013). Electricity Consumption in Developing Countries. *Asian Journal of Social Science & Humanities*. **2**(2): 84–90.

- Karlin, B. (2012). Public acceptance of smart meters: Integrating psychology and practice. *In: ACEEE Summer Study on Energy Efficiency in Buildings*. (Edited by ACEEE). 12-17 October 2012, California USA, Vol. 7. pp 102–113.
- Kempener, R., D’Ortigue, O. L., Saygin, D., Skeer, J., Vinci, S. and Gielen, D. (2015). Off-grid renewable energy systems: status and methodological issues. IRENA. <http://www.irena.org/publications/2015/Feb/Off-grid-renewable-energy-systems-Status-and-methodological-issues>. Accessed on September 20, 2016
- Khan, M. A., Javaid, N., Arif, M., Saud, S., Qasim, U. and Khan, Z. A. (2014). Peak Load Scheduling in Smart Grid Communication Environment. *In: Advanced Information Networking and Applications (AINA). 2014 IEEE 28th International Conference on*. (Edited by IEEE). 13-16 May 2014, Victoria Canada, pp 1025–1032.
- Khan, M. A., Javaid, N., Mahmood, A., Khan, Z. A. and Alrajeh, N. (2015). A generic demandside management model for smart grid. *International Journal of Energy Research*. **39**(7): 954–964.
- Khodaei, A., Shahidehpour, M. and Bahramirad, S. (2011). SCUC with hourly demand response considering intertemporal load characteristics. *IEEE Transactions on Smart Grid*. **2**(3): 564–571.
- Kimani, M. (2008). Powering up Africa’s Economies. *Africa Renewal*. **22**: 3–8.
- Kirschen, D. S. (2003). Demand-side view of electricity markets. *Power Systems, IEEE Transactions on*. **18**(2): 520–527.
- Kishore, S. and Snyder, L. V. (2010). Control mechanisms for residential electricity demand in smartgrids. *In: Smart Grid Communications (SmartGridComm). 2010 First IEEE International Conference on*. (Edited by IEEE). 4-6 October 2014, Gaithersburg MD USA, pp 443–448.
- Kleit, A. N. (2007). *Electric Choices: Deregulation and the Future of Electric Power*. Rowman & Littlefield., Maryland.

- Kriett, P. O. and Salani, M. (2012). Optimal control of a residential microgrid. *Energy*. **42**(1): 321–330.
- Kumar, A. and Sekhar, C. (2012). DSM based congestion management in pool electricity markets with FACTS devices. *Energy Procedia*. **14**: 94–100.
- Kuzlu, M., Pipattanasomporn, M. and Rahman, S. (2012). Hardware demonstration of a home energy management system for demand response applications. *IEEE Transactions on Smart Grid*. **3**(4): 1704–1711.
- Leadbetter, J. and Swan, L. (2012). Battery storage system for residential electricity peak demand shaving. *Energy and Buildings*. **55**: 685–692.
- Lewis, N. S. and Nocera, D. G. (2006). Powering the planet: Chemical challenges in solar energy utilization. *Proceedings of the National Academy of Sciences*. **103**(43): 15729–15735.
- Li, Z. and Guo, J. (2006). Wisdom about age [aging electricity infrastructure]. *IEEE Power and Energy Magazine*. **4**(3): 44–51.
- Liberati, A., Altman, D. G., Tetzlaff, J., Mulrow, C., Gøtzsche, P. C., Ioannidis, J. P. A., Clarke, M., Devereaux, P. J., Kleijnen, J. and Moher, D. (2009). The PRISMA statement for reporting systematic reviews and meta-analyses of studies that evaluate health care interventions: explanation and elaboration. *PLoS Medicine*. **162**(11):777-802.
- Liu, Y., Yuen, C., Huang, S., Hassan, N. U., Wang, X. and Xie, S. (2014). Peak-to-average ratio constrained demand-side management with consumer's preference in residential smart grid. *IEEE Journal of Selected Topics in Signal Processing*. **8**(6): 1084–1097.
- Livengood, D. and Larson, R. (2009). The energy box: Locally automated optimal control of residential electricity usage. *Service Science*. **1**(1): 1–16.
- Logenthiran, T., Srinivasan, D. and Shun, T. Z. (2012). Demand side management in smart grid using heuristic optimization. *IEEE Transactions on Smart Grid*. **3**(3): 1244–1252.

- Lujano-Rojas, J. M., Monteiro, C., Dufo-Lopez, R. and Bernal-Agustin, J. L. (2012). Optimum residential load management strategy for real time pricing (RTP) demand response programs. *Energy Policy*. **45**: 671–679.
- Lund, D., MacGillivray, C., Turner, V. and Morales, M. (2014). Worldwide and regional internet of things (iot) 2014–2020 forecast: A virtuous circle of proven value and demand. International Data Corporation (IDC). <http://www.business.att.com>. Accessed on February 26, 2017.
- Magnier, L. and Haghghat, F. (2010). Multiobjective optimization of building design using TRNSYS simulations, genetic algorithm, and Artificial Neural Network. *Building and Environment*. **45**(3): 739–746.
- Maity, I. and Rao, S. (2010). Simulation and pricing mechanism analysis of a solar-powered electrical microgrid. *Systems Journal, IEEE*. **4**(3): 275–284.
- Martinaitis, V., Zavadskas, E. K., Motuziene, V. and Vilutiene, T. (2015). Importance of occupancy information when simulating energy demand of energy efficient house: A case study. *Energy and Buildings*. **101**: 64–75.
- Matallanas, E., Castillo-Cagigal, M., Gutiérrez, A., Monasterio-Huelin, F., Caamaño-Martín, E., Masa, D. and Jiménez-Leube, J. (2012). Neural network controller for active demand-side management with PV energy in the residential sector. *Applied Energy*. **91**(1): 90–97.
- Mays, J. and Klabjan, D. (2016). Optimization of Time-Varying Electricity Rates. *The Energy Journal*. **38**(5): 67-91.
- Mazidi, M., Zakariazadeh, A., Jadid, S. and Siano, P. (2014). Integrated scheduling of renewable generation and demand response programs in a microgrid. *Energy Conversion and Management*. **86**: 1118–1127.
- McDaniel, P. and McLaughlin, S. (2009). Security and privacy challenges in the smart grid. *IEEE Security & Privacy*. **7**(3): 75–77.

- Mediwaththe, C. P., Stephens, E. R., Smith, D. B. and Mahanti, A. (2015). Competitive Energy Trading Framework for Demand-side Management in Neighborhood Area Networks. Arxiv. <https://arxiv.org/pdf/1512.03440>. Accessed on July 13, 2017.
- Mediwaththe, C. P., Stephens, E. R., Smith, D. B. and Mahanti, A. (2016). A dynamic game for electricity load management in neighborhood area networks. *IEEE Transactions on Smart Grid*. **7**(3): 1329–1336.
- Mehdi, G. and Roshchin, M. (2015). Electricity Consumption Constraints for Smart-home Automation: An Overview of Models and Applications. *Energy Procedia*. **83**: 60–68.
- Meng, F.-L., Zeng, X.-J., Jones, A. V. and Ng, N. (2013). An Optimal Real-time Pricing Algorithm for the Smart Grid: A Bi-level Programming Approach. *In: ICCSW*. 26-27 September 2013, London United Kingdom, pp 81–88.
- Mesarić, P. and Krajcar, S. (2015). Home demand side management integrated with electric vehicles and renewable energy sources. *Energy and Buildings*. **108**: 1–9.
- Mideksa, T. and Kallbekken, S. (2010). The impact of climate change on the electricity market: A review. *Energy Policy*. **38**(7): 3579–3585.
- Ministry of Energy and Minerals, Tanzania. (2014). Electricity Supply Industry Reform Strategy and Roadmap 2014 - 2025. Ministry of Energy and Minerals. <https://mem.go.tz/wp-content/uploads/2015/11/24.11.15ESQB-FOR-Q1-1.pdf>. Accessed on August 17, 2017.
- Mohsenian-Rad, A.-H. and Leon-Garcia, A. (2010). Optimal residential load control with price prediction in real-time electricity pricing environments. *Smart Grid, IEEE Transactions on*. **1**(2): 120–133.
- Mohsenian-Rad, A.-H., Wong, V. W. S., Jatskevich, J., Schober, R. and Leon-Garcia, A. (2010). Autonomous demand-side management based on game-theoretic energy consumption scheduling for the future smart grid. *Smart Grid, IEEE Transactions on*. **1**(3): 320–331.

- Molina-Garcia, A., Kessler, M., Fuentes, J. A. and Gomez-Lazaro, E. (2011). Probabilistic characterization of thermostatically controlled loads to model the impact of demand response programs. *IEEE Transactions on Power Systems*. **26**(1): 241–251.
- Momoh, J. (2012). Smart grid: fundamentals of design and analysis. Vol. 63. John Wiley & Sons.
- Mulder, G., De Ridder, F. and Six, D. (2010). Electricity storage for grid-connected household dwellings with PV panels. *Solar Energy*. **84**(7): 1284–1293.
- Müsgens, F., Ockenfels, A. and Peek, M. (2014). Economics and design of balancing power markets in Germany. *International Journal of Electrical Power & Energy Systems*. **55**: 392–401.
- National Renewable Energy Laboratory. (2017). PVWatts Calculator. <http://pvwatts.nrel.gov/pvwatts.php>. Accessed on February 19, 2017.
- Negeri, E. and Baken, N. (2012). Distributed storage management using dynamic pricing in a self-organized energy community. *In: International Workshop on Self-Organizing Systems*. (Edited by Springer). 15-16 March 2012, Delft Netherlands, pp 1–12.
- Nemet, G. F. (2009). Demand-pull, technology-push, and government-led incentives for non-incremental technical change. *Research Policy*. **38**(5): 700–709.
- Nguyen, D. T. and Le, L. B. (2014). Joint optimization of electric vehicle and home energy scheduling considering user comfort preference. *IEEE Transactions on Smart Grid*. **5**(1): 188–199.
- Obergassel, W., Arens, C., Hermwille, L., Kreibich, N., Mersmann, F., Ott, H. E. and Wang-Helmreich, H. (2016). Phoenix from the Ashes: An Analysis of the Paris Agreement to the United Nations Framework Convention on Climate Change. *Environmental Law and Management*. **27**(6): 243–262.
- Oulton, N. (2007). Ex post versus ex ante measures of the user cost of capital. *Review of Income and Wealth*. **53**(2): 295–317.

- Ozturk, Y., Senthilkumar, D., Kumar, S. and Lee, G. (2013). An intelligent home energy management system to improve demand response. *IEEE Transactions on Smart Grid*. **4**(2): 694–701.
- Palensky, P. and Dietrich, D. (2011). Demand side management: Demand response, intelligent energy systems, and smart loads. *Industrial Informatics, IEEE Transactions on*. **7**(3): 381–388.
- Papaefthymiou, G., Hasche, B. and Nabe, C. (2012). Potential of heat pumps for demand side management and wind power integration in the German electricity market. *IEEE Transactions on Sustainable Energy*. **3**(4): 636–642.
- Pascual, J., Barricarte, J., Sanchis, P. and Marroyo, L. (2015). Energy management strategy for a renewable-based residential microgrid with generation and demand forecasting. *Applied Energy*. **158**: 12–25.
- Pedrasa, M. A. A., Spooner, T. D. and MacGill, I. F. (2009). Scheduling of demand side resources using binary particle swarm optimization. *IEEE Transactions on Power Systems*. **24**(3): 1173–1181.
- Pedrasa, M. A. A., Spooner, T. D. and MacGill, I. F. (2010). Coordinated scheduling of residential distributed energy resources to optimize smart home energy services. *IEEE Transactions on Smart Grid*. **1**(2): 134–143.
- Pina, A., Silva, C. and Ferrão, P. (2012). The impact of demand side management strategies in the penetration of renewable electricity. *Energy*. **41**(1): 128–137.
- Pipattanasomporn, M., Kuzlu, M. and Rahman, S. (2012). An algorithm for intelligent home energy management and demand response analysis. *IEEE Transactions on Smart Grid*. **3**(4): 2166–2173.
- Porter, M. E. and Heppelmann, J. E. (2014). How smart, connected products are transforming competition. *Harvard Business Review*. **92**(11): 64–88.
- Privat, G. (2006). From smart devices to ambient communication. In: *From Smart Devices to Ambient Communication*. 6 March 2006, Brussels Belgium, pp 1–11.

- Radziszewska, W., Kowalczyk, R. and Nahorski, Z. (2014). El farol bar problem, potluck problem and electric energy balancing-on the importance of communication. *In: Computer Science and Information Systems (FedCSIS). 2014 Federated Conference on.* (Edited by IEEE). 7-10 September 2014, Warsaw Poland, pp 1515–1523.
- Rahman, M. M., Kuzlu, M., Pipattanasomporn, M. and Rahman, S. (2014). Architecture of web services interface for a Home Energy Management system. *In: Innovative Smart Grid Technologies Conference (ISGT). 2014 IEEE PES.* (Edited by IEEE). 19-22 February 2014. Washington DC USA, pp 1–5.
- Rajeev, T. and Ashok, S. (2014). Demand management of electric vehicle charging based on a cloud computing framework. *In: Transportation Electrification Asia-Pacific (ITEC Asia-Pacific). 2014 IEEE Conference and Expo.* (Edited by IEEE). 31 August-3 September 2014, Beijing China, pp 1–4.
- Ramanathan, B. and Vittal, V. (2008). A framework for evaluation of advanced direct load control with minimum disruption. *IEEE Transactions on Power Systems.* **23**(4): 1681–1688.
- Rassenti, S. J., Smith, V. L. and Wilson, B. J. (2002). Demand-side bidding will reduce the level and volatility of electricity prices. *INDEPENDENT REVIEW-OAKLAND-* **6**(3): 441–446.
- Riffonneau, Y., Bacha, S., Barruel, F. and Ploix, S. (2011). Optimal power flow management for grid connected PV systems with batteries. *IEEE Transactions on Sustainable Energy.* **2**(3): 309–320.
- Roscoe, A. J. and Ault, G. (2010). Supporting high penetrations of renewable generation via implementation of real-time electricity pricing and demand response. *IET Renewable Power Generation.* **4**(4): 369–382.
- Roy, A., Kedare, S. B. and Bandyopadhyay, S. (2010). Optimum sizing of wind-battery systems incorporating resource uncertainty. *Applied Energy.* **87**(8): 2712–2727.

- Roy, S., Byrne, J. and Pickering, C. (2012). A systematic quantitative review of urban tree benefits, costs, and assessment methods across cities in different climatic zones. *Urban Forestry & Urban Greening*. **11**(4): 351–363.
- Ruelens, F., Claessens, B., Vandael, S., De Schutter, B., Babuska, R. and Belmans, R. (2015). Residential Demand Response Applications Using Batch Reinforcement Learning. Arxiv. <https://arxiv.org/abs/1504.02125>. Accessed on May 21, 2017.
- Rusitschka, S., Gerdes, C. and Eger, K. (2009). A low-cost alternative to smart metering infrastructure based on peer-to-peer technologies. In: *Energy Market, 2009. EEM 2009. 6th International Conference on the European*. (Edited by IEEE). 27-29 May 2009, Leuven Belgium, pp 1–6.
- Safdarian, A., Fotuhi-Firuzabad, M. and Lehtonen, M. (2014). A distributed algorithm for managing residential demand response in smart grids. *IEEE Transactions on Industrial Informatics*. **10**(4): 2385–2393.
- Samadi, P., Mohsenian-Rad, H., Schober, R. and Wong, V. W. S. (2012). Advanced demand side management for the future smart grid using mechanism design. *IEEE Transactions on Smart Grid*. **3**(3): 1170–1180.
- Sambo, A. S., Garba, B., Zarma, I. H. and Gaji, M. M. (2012). Electricity generation and the present challenges in the Nigerian power sector. *Journal of Energy and Power Engineering*. **6**(7): 1050.
- Shao, S., Pipattanasomporn, M. and Rahman, S. (2011). Demand response as a load shaping tool in an intelligent grid with electric vehicles. *IEEE Transactions on Smart Grid*. **2**(4): 624–631.
- Shao, S., Pipattanasomporn, M. and Rahman, S. (2012). Grid integration of electric vehicles and demand response with customer choice. *IEEE Transactions on Smart Grid*. **3**(1): 543–550.
- Siano, P. (2014). Demand response and smart grids-A survey. *Renewable and Sustainable Energy Reviews*. **30**: 461–478.

- Sieminski, A. (2014). International energy outlook. Energy Information Administration (EIA). <https://www.eia.gov/outlooks/ieo/>. Accessed on June 3, 2017.
- Singh, N. and Rao, S. (2010). Modeling and reducing power consumption in large IT systems. *In: Systems Conference, 2010 4th Annual IEEE*. (Edited by IEEE). 5-8 April 2010, California USA, pp 178–183.
- Snow, S. and Brereton, M. (2012). Beyond demand management: The value of sharing electricity information. *In: Proceedings of the 26th Annual BCS Interaction Specialist Group Conference on People and Computers*. (Edited by British Computer Society). 12-14 September 2012, Birmingham United Kingdom, pp 392–397.
- Soliman, H. M. and Leon-Garcia, A. (2014). Game-theoretic demand-side management with storage devices for the future smart grid. *IEEE Transactions on Smart Grid*. **5**(3): 1475–1485.
- Sørensen, K., den Broucke, S., Fullam, J., Doyle, G., Pelikan, J., Slonska, Z. and Brand, H. (2012). Health literacy and public health: a systematic review and integration of definitions and models. *BMC Public Health*. **12**(1), 80.
- Steven, R., Pickering, C. and Castley, J. G. (2011). A review of the impacts of nature based recreation on birds. *Journal of Environmental Management*. **92**(10), 2287–2294.
- Surles, W. and Henze, G. P. (2012). Evaluation of automatic priced based thermostat control for peak energy reduction under residential time-of-use utility tariffs. *Energy and Buildings*. **49**: 99–108.
- TanESCO (2017). Distribution. TanESCO. <http://www.tanESCO.co.tz/index.php/about-us/functions/distribution>. Accessed on September 8, 2017.
- Tascikaraoglu, A., Boynuegri, A. R. and Uzunoglu, M. (2014). A demand side management strategy based on forecasting of residential renewable sources: A smart home system in Turkey. *Energy and Buildings*. **80**: 309–320.
- Totamane, R., Dasgupta, A. and Rao, S. (2009). Air Cargo demand modeling and prediction. *Systems Journal, IEEE*. **8**(1): 52–62.

- Traber, T. and Kemfert, C. (2011). Gone with the wind? Electricity market prices and incentives to invest in thermal power plants under increasing wind energy supply. *Energy Economics*. **33**(2): 249–256.
- Tsui, K. M. and Chan, S.-C. (2012). Demand response optimization for smart home scheduling under real-time pricing. *IEEE Transactions on Smart Grid*. **3**(4): 1812–1821.
- Ulbig, A., Borsche, T. S. and Andersson, G. (2014). Impact of low rotational inertia on power system stability and operation. *IFAC Proceedings Volumes*. **47**(3): 7290–7297.
- European Union (2014). Communication from the Commission to the European Parliament, the Council, the European Economic and Social Committee and the Committee of the Regions, Bryssel. EU. <https://eur-lex.europa.eu/legal-content/EN/ALL/?uri=CELEX%3A52010DC0245R%2801%29>. Accessed on November 26, 2016.
- USA (2007). Energy independence and security act of 2007. US Government Printing Office.
- USA, Department of Energy. (2015). An Assessment of Energy Technologies and Research Opportunities. USA Department of Energy. https://www.energy.gov/sites/prod/files/2015/09/f26/Quadrennial-Technology-Review-2015_0.pdf. Accessed on March 18, 2017.
- Vandaele, N. and Porter, W. (2015), Renewable Energy in Developing and Developed Nations: Outlooks to 2040. *Journal of Undergraduate Research*. **15**(3): 1–7.
- Verbong, G. P. J., Beemsterboer, S. and Sengers, F. (2013). Smart grids or smart users? Involving users in developing a low carbon electricity economy. *Energy Policy*. **52**: 117–125.
- Vinois, J. (2012). DG ENER Working Paper: The future role and challenges of Energy Storage. European Commission, Director General for Energy. https://ec.europa.eu/energy/sites/ener/files/energy_storage.pdf. Accessed on April 25, 2017.
- Vivekananthan, C., Mishra, Y., Ledwich, G. and Li, F. (2014). Demand response for residential appliances via customer reward scheme. *IEEE Transactions on Smart Grid*. **5**(2): 809–820.

- Wacks, K. P. (1991). Utility load management using home automation. *IEEE Transactions on Consumer Electronics*. **37**(2): 168–174.
- Walawalkar, R. S. (2008). Economics of emerging electric energy storage technologies and demand response in deregulated electricity markets. CEIC. <https://ceic.tepper.cmu.edu/-/media/files/tepper/centers/ceic/publications>. Accessed on August 28, 2017.
- Wang, D., Parkinson, S., Miao, W., Jia, H., Crawford, C. and Djilali, N. (2012). Online voltage security assessment considering comfort-constrained demand response control of distributed heat pump systems. *Applied Energy*. **96**: 104–114.
- Wang, X., Palazoglu, A. and El-Farra, N. H. (2015). Operational optimization and demand response of hybrid renewable energy systems. *Applied Energy*. **143**: 324–335.
- Wang, Z., Gu, C., Li, F., Bale, P. and Sun, H. (2013). Active demand response using shared energy storage for household energy management. *IEEE Transactions on Smart Grid*. **4**(4): 1888–1897.
- Warren, P. (2013). Electricity demand-side management: best practice programmes for the UK. *Energy and Sustainability IV*. **176**: 69.
- Warren, P. (2014a). A review of demand-side management policy in the UK. *Renewable and Sustainable Energy Reviews*. **29**: 941–951.
- Warren, P. (2014b). The use of systematic reviews to analyse demand-side management policy. *Energy Efficiency*. **7**(3): 417–427.
- Wijaya, T. K., Papaioannou, T. G., Liu, X. and Aberer, K. (2013). Effective consumption scheduling for demand-side management in the smart grid using non-uniform participation rate. In: *Sustainable Internet and ICT for Sustainability (SustainIT)*. 2013. (edited by IEEE). 30-31 October 2013, Palermo Italy, pp 1–8.
- Wu, Z., Tazvinga, H. and Xia, X. (2015). Demand side management of photovoltaic-battery hybrid system. *Applied Energy*. **148**: 294–304.

- Yoon, J. H., Baldick, R. and Novoselac, A. (2014). Dynamic demand response controller based on real-time retail price for residential buildings. *IEEE Transactions on Smart Grid*. **5**(1): 121–129.
- Yu, Z., Jia, L., Murphy-Hoye, M. C., Pratt, A. and Tong, L. (2013). Modeling and stochastic control for home energy management. *IEEE Transactions on Smart Grid*. **4**(4): 2244–2255.
- Zehir, M. A. and Bagriyanik, M. (2012). Demand side management by controlling refrigerators and its effects on consumers. *Energy Conversion and Management*. **64**: 238–244.
- Zipperer, A., Aloise-Young, P. A., Suryanarayanan, S., Roche, R., Earle, L., Christensen, D., Bauleo, P. and Zimmerle, D. (2013). Electric energy management in the smart home: Perspectives on enabling technologies and consumer behavior. *Proceedings of the IEEE*. **101**(11): 2397–2408.

APPENDICES

Appendix 1: Details of 84 Papers Proposing Various DSM Programs

Authors (Year)	Journal	Study Location
Africa-South Africa		
Wu <i>et al.</i> (2015)	Applied Energy	
Africa-Tunisia		
Chaabene <i>et al.</i> (2007)	Applied Energy	Tunisia
Asia-China		
Liu <i>et al.</i> (2014)	IEEE Journal of Selected Topics in Signal Processing	
Tsui and Chan (2012)	IEEE Transactions on Smart Grid	
Chu and Jong (2008)	IEEE Transactions on Power Systems	Taiwan
Asia-India		
Roy <i>et al.</i> (2010)	Applied Energy	
Asia-Saudi Arabia		
El-Amin <i>et al.</i> (1999)	Electric Power Systems Research	
Asia-Iran		
Aalami <i>et al.</i> (2010)	Electric Power Systems Research	
Hakimi and Moghaddas-Tafreshi (2014)	IEEE Transactions on Smart Grid	Ekbatan, Iran
Safdarian <i>et al.</i> (2014)	IEEE Transactions on Industrial Informatics	Finland
Aalami <i>et al.</i> (2009)	Applied Energy	Iran
Asia-Pakistan		
Arif <i>et al.</i> (2014)	Energy Efficiency	
Asia-Singapore		
Logenthiran <i>et al.</i> (2012)	IEEE Transactions on Smart Grid	
Asia-Turkey		
Tascikaraoglu <i>et al.</i> (2014)	Energy and Buildings	Turkey
Zehir and Bagriyanik (2012)	Energy Conversion and Management	Turkey

Appendix 2: Details of 84 Papers Proposing Various DSM Programs-continued

Authors (Year)	Journal	Study Location
Oceania-Australia		
Deilami <i>et al.</i> (2011)	IEEE Transactions on Smart Grid	Western Australia
Pedrasa <i>et al.</i> (2010)	IEEE Transactions on Smart Grid	
Vivekananthan <i>et al.</i> (2014)	IEEE Transactions on Smart Grid	Australia
Pedrasa <i>et al.</i> (2009)	IEEE Transactions on Power Systems	
Europe-Denmark		
Costanzo <i>et al.</i> (2012)	IEEE Transactions on Smart Grid	
Europe-Croatia		
Mesarić and Krajcar (2015)	Energy and Buildings	
Europe-Switzerland		
Kriett and Salani (2012)	Energy	Switzerland
Europe-Romania		
Bualan <i>et al.</i> (2011)	Energy and Buildings	
Europe-Ireland		
Finn <i>et al.</i> (2013)	Applied Energy	
Europe-Belgium		
Mulder <i>et al.</i> (2010)	Solar energy	Belgium
Europe-France		
Riffonneau <i>et al.</i> (2011)	IEEE Transactions on Sustainable Energy	France
Europe-Portugal		
Fernandes <i>et al.</i> (2014)	Energy and Buildings	
Europe-UK		
Roscoe and Ault (2010)	IET Renewable Power Generation	UK
Wang <i>et al.</i> (2013)	IEEE Transactions on Smart Grid	UK
Europe-Finland		
Alimohammadisagvand <i>et al.</i> (2015)	Indoor and Built Environment	Finland
Ali <i>et al.</i> (2014)	Electric Power Systems Research	Finland
Europe-Germany		
Fischer <i>et al.</i> (2016)	IEEE Transactions on Smart Grid	Germany
Gottwalt <i>et al.</i> (2011)	Energy Policy	Germany
Papaefthymiou <i>et al.</i> (2012)	IEEE Transactions on Sustainable Energy	Germany
Europe-Italy		
Di Giorgio and Pimpinella (2012)	Applied Energy	
De Angelis <i>et al.</i> (2013)	IEEE Transactions on Industrial Informatics	
Ferruzzi <i>et al.</i> (2015)	Intelligent Industrial Systems	
Arteconi <i>et al.</i> (2013)	Applied Thermal Engineering	Northern Ireland
Cecati <i>et al.</i> (2011)	IEEE Transactions on Sustainable Energy	
Mazidi <i>et al.</i> (2014)	Energy Conversion and Management	
Boaro <i>et al.</i> (2013)	Cognitive Computation	USA

Appendix 3: Details of 84 Papers Proposing Various DSM Programs-continued

Authors (Year)	Journal	Study Location
Europe-Spain		
Matallanas <i>et al.</i> (2012)	Applied Energy	Spain
Caamano-Martin <i>et al.</i> (2011)	Solar Energy	
Atzeni <i>et al.</i> (2013a)	IEEE Transactions on Smart Grid	
Europe-Spain		
Lujano-Rojas <i>et al.</i> (2012)	Energy Policy	Zaragoza, Spain
Álvarez-Bel <i>et al.</i> (2013)	Energy Efficiency	Spain
Molina-Garcia <i>et al.</i> (2011)	IEEE Transactions on power systems	
Pascual <i>et al.</i> (2015)	Applied Energy	Spain
Castillo-Cagigal <i>et al.</i> (2011)	Energy Conversion and Management	Spain
Escrivá-Escrivá <i>et al.</i> (2010)	Energy and Buildings	Spain
Faxas-Guzmán <i>et al.</i> (2014)	Renewable Energy	Spain
Gutiérrez <i>et al.</i> (2009)	Sensors	Spain
North America-Canada		
Afram and Janabi-Sharifi (2015)	Applied Energy	Vaughan, Ontario Canada
Bozchalui <i>et al.</i> (2012)	IEEE Transactions on Smart Grid	Ontario, Canada
Broeer <i>et al.</i> (2014)	Applied Energy	Olympic Peninsula, USA
Erol-Kantarci and Mouftah (2011)	IEEE Transactions on Smart Grid	
Leadbetter and Swan (2012)	Energy and buildings	Canada
Magnier and Haghghat (2010)	Building and Environment	Canada
Mohsenian-Rad <i>et al.</i> (2010)	IEEE transactions on Smart Grid	
Nguyen and Le (2014)	IEEE Transactions on Smart Grid	Canada
Samadi <i>et al.</i> (2012)	IEEE Transactions on Smart Grid	
Wang <i>et al.</i> (2012)	Applied Energy	
Mohsenian-Rad and Leon-Garcia (2010)	IEEE Transactions on Smart Grid	USA

Appendix 4: Details of 84 Papers Proposing Various DSM Programs-continued

Authors (Year)	Journal	Study Location
North America-USA		
Yu <i>et al.</i> (2013)	IEEE Transactions on Smart Grid	Arizona,USA
Hu and Li (2013)	IEEE Transactions on Smart grid	
Adika and Wang (2014)	International Journal of Electrical Power & Energy Systems	
Alahmad <i>et al.</i> (2012)	IEEE Transactions on Industrial Electronics	Omaha, USA
Hubert and Grijalva (2012)	IEEE Transactions on Smart Grid	
Khodaei <i>et al.</i> (2011)	IEEE Transactions on Smart Grid	
Kuzlu <i>et al.</i> (2012)	IEEE Transactions on Smart grid	
Livengood and Larson (2009)	Service Science	
Ozturk <i>et al.</i> (2013)	IEEE Transactions on Smart Grid	
Pipattanasomporn <i>et al.</i> (2012)	IEEE Transactions on Smart Grid	USA
Shao <i>et al.</i> (2011)	IEEE Transactions on Smart Grid	
Shao <i>et al.</i> (2012)	IEEE Transactions on Smart Grid	USA
Yoon <i>et al.</i> (2014)	IEEE Transactions on Smart Grid	Texas, USA
Adika and Wang (2013)	IEEE Transactions on Smart Grid	
Gatsis and Giannakis (2012)	IEEE Transactions on Smart Grid	
Giraud and Salameh (2001)	IEEE Transactions on Energy Conversion	USA
Huang and Liu (2013)	Neural Computing and Applications	
Ramanathan and Vittal (2008)	IEEE Transactions on Power Systems	
Surles and Henze (2012)	Energy and Buildings	USA
Wacks (1991)	IEEE Transactions on Consumer Electronics	
Wang <i>et al.</i> (2015)	Applied Energy	

Appendix 5: Actual Demand vs Optimal Demand for Utility 1

Hour	Actual	Optimal	% Discrepancy
0100	1911.8	1934	1.16
0200	1753.5	1939	10.58
0300	1764.4	1854	5.08
0400	1874.2	1873	0.06
0500	1902.5	1925	1.18
0600	2116.1	2060	2.65
0700	2514.8	2419	3.81
0800	2154	2720	26.28
0900	2117.5	2812	32.80
1000	2915.7	2858	1.98
1100	2968.1	2878	3.04
1200	2778.4	2956	6.39
1300	2182.4	2759	26.42
1400	2123.9	2822	32.87
1500	2229.6	2744	23.07
1600	2120.7	2690	26.84
1700	2434.7	2675	9.87
1800	2674.7	2903	8.54
1900	2751.5	2946	7.07
2000	2510.7	2748	9.45
2100	2347.7	2572	9.55
2200	2053.8	2459	19.73
2300	1983.2	2276	14.76
2400	1994	2126	6.62

Appendix 6: Actual Demand vs Optimal Demand for Utility 2

Hour	Actual	Optimal	% Discrepancy
0100	1911.8	1970	3.04
0200	1753.5	1878	7.10
0300	1764.4	1890	7.12
0400	1874.2	1863	0.60
0500	1902.5	1901	0.08
0600	2116.1	2013	4.87
0700	2514.8	2397	4.68
0800	2154	2707	25.67
0900	2117.5	2824	33.36
1000	2915.7	2834	2.80
1100	2968.1	2930	1.28
1200	2778.4	2882	3.73
1300	2182.4	2750	26.01
1400	2123.9	2732	28.63
1500	2229.6	2752	23.43
1600	2120.7	2644	24.68
1700	2434.7	2712	11.39
1800	2674.7	2904	8.57
1900	2751.5	2932	6.56
2000	2510.7	2841	13.16
2100	2347.7	2641	12.49
2200	2053.8	2452	19.39
2300	1983.2	2314	16.68
2400	1994	2102	5.42

Appendix 7: Actual Demand vs Optimal Demand for Utility 3

Hour	Actual	Optimal	% Discrepancy
0100	1911.8	1953	2.16
0200	1753.5	1908	8.81
0300	1764.4	1848	4.74
0400	1874.2	1876	0.10
0500	1902.5	1899	0.18
0600	2116.1	1969	6.95
0700	2514.8	2392	4.88
0800	2154	2644	22.75
0900	2117.5	2796	32.04
1000	2915.7	2929	0.46
1100	2968.1	2931	1.25
1200	2778.4	2839	2.18
1300	2182.4	2755	26.24
1400	2123.9	2770	30.42
1500	2229.6	2773	24.37
1600	2120.7	2635	24.25
1700	2434.7	2696	10.73
1800	2674.7	2898	8.35
1900	2751.5	2936	6.71
2000	2510.7	2787	11.00
2100	2347.7	2610	11.17
2200	2053.8	2437	18.66
2300	1983.2	2273	14.61
2400	1994	2091	4.86

Appendix 8: Actual Demand vs Optimal Demand for Utility 4

Hour	Actual	Optimal	% Discrepancy
0100	1911.8	1947	1.84
0200	1753.5	1876	6.99
0300	1764.4	1876	6.33
0400	1874.2	1889	0.79
0500	1902.5	1892	0.55
0600	2116.1	2054	2.93
0700	2514.8	2329	7.39
0800	2154	2661	23.54
0900	2117.5	2762	30.44
1000	2915.7	2764	5.20
1100	2968.1	2917	1.72
1200	2778.4	2844	2.36
1300	2182.4	2780	27.38
1400	2123.9	2681	26.23
1500	2229.6	2683	20.34
1600	2120.7	2658	25.34
1700	2434.7	2665	9.46
1800	2674.7	2866	7.15
1900	2751.5	2904	5.54
2000	2510.7	2748	9.45
2100	2347.7	2654	13.05
2200	2053.8	2455	19.53
2300	1983.2	2327	17.34
2400	1994	2102	5.42